

TARUSTUNNEL600

For product specifications, materials and colours, please refer to the details inside

Tarus Tunnel 600

Technical data

INSTALL

Road tunnels

ACCESSIBILITY



Openable

Openable fixture with basic tools
Replaceable internal components
using basic tools.

OPTICAL TECHNOLOGY



Glassed

Refracting optical system consist of singlechip LED, PMMA lenses with 30 years of warranty against UV and yellowing by aging, aluminium reflector having a purity of 99,7% and extra clear tempered glass.

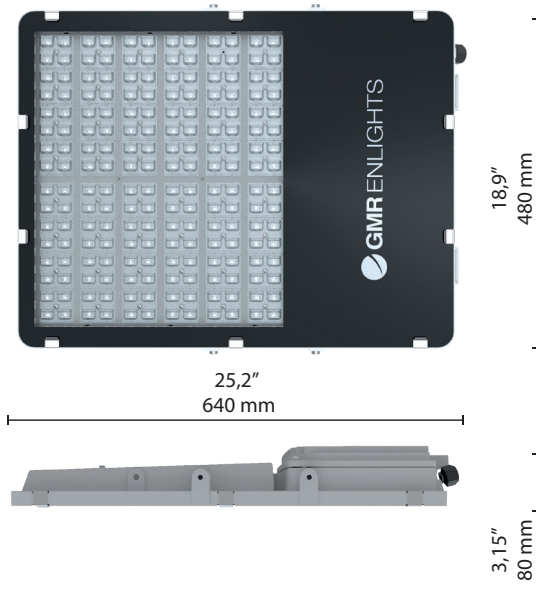

Scale: 1:10

Max. weight

33 lb (15Kg)

EPA (CXS)

Front: 2,9ft² (0,27 m²)

STANDARD

Compliance: UL Standard 1598-CSA C22,2no.250.0.

CONFORMITY | PROTECTION

Conformity



Salt spray test

ISO 9227



Vibration test passed

IEC 60068-2-6



Safety classes



Protection classes



Photobiological safety



Classe 0 Exempt group IEC/TR62471

PLUS



CUT OFF



OPTICAL FLEXIBILITY



LOW GLARE



COMPLIANT

LIGHTING FIXTURE FEATURES

General features

Power source:	120-277V 50/60Hz tolerance +/-10%
Current supply:	350 mA 525 mA 700 mA (P _{max} = 415W)
Power Factor THD:	≥0.95 <10 % (At full load)
Expected life (Ta=77°F 25°C):	> 100.000 h L90B10 @ LED 700mA
Operational temperature (Ta):	T _{min} = -40°F (-40°C) T _{max} = 131°F (55°C) 700 mA
Storage temperature:	-40°F/+176°F (-40°C/+80°C)
Overcharge protection:	Main surge immunity up to 10kV
Disconnecter:	Optional
Standard functions:	Current fixed CLO
Standard equipment:	Power cable type FG70M106 / 1kV 2x1.5, plug type IEC309 2P + T 230V 16A- IP68

Materials

Lighting fixture:	Die cast aluminium EN1706
Optical system:	Optics in PMMA Aluminium reflector, 99,7% oxidised and polished purity
Screen:	Screen-printed ultraclear tempered glass Th. 0,15in (4mm)
Gaskets:	Removable silicon
Cable gland:	Polyamide PA66 PG16 Ø 0,55in (14mm) MAX
Screws and bolts:	AISI 304 stainless steel
Bracket:	AISI 304 stainless steel
Fixture color:	GMR light
Silkscreen color:	RAL 9005

LED FEATURES

LED data 4.000 K - 700mA:	340 lm/LED 180 lm/W 77°F (25°C) [Tj] ≤ 3 step MacAdam
Color temperature:	4.000 K 5.700 K CRI ≥ 70

REINFORCEMENT LIGHTING

TT6 C

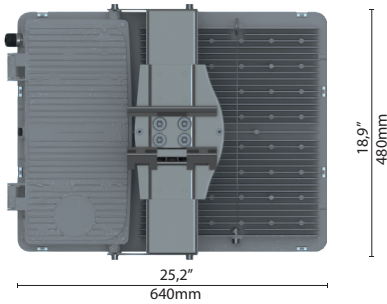
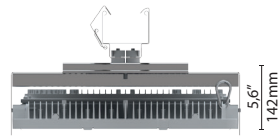
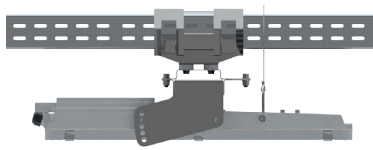

OPTIONAL

Mechanical equipment: Protection grille

Additional surge protector device: SPD | Max peak current 10kV/kA 8/20µs

Additional surge protector device SPD 400: SPD | Max peak current 10kV 8/20µs + permanent overvoltage protection higher than 270Vac

Electrical equipment: Disconnecter and cable clamp | cross section AWG14 ÷ AWG6

Optional functions: DALI-DALI2 | DALI SENSOR

Connectors and sockets: NM (Nema Socket) | LM (Lumawise Zhaga Socket)

FOCUS: FIXING TUNNEL (*)

Rotation axes for cable channel installation

The tunnel version of Tarus was implemented to ensure safety and reliability in the permanent and reinforcement lighting of tunnels and galleries. The fastening systems developed provide for the possibility of adjusting the inclination of the body to compensate for any anomalies in the support.

TARUS TUNNEL 600
Reinforcement lighting Y

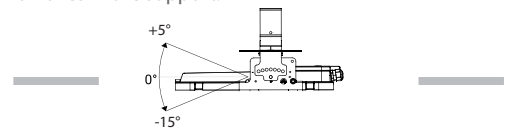

TARUS TUNNEL 600
Reinforcement lighting XZ

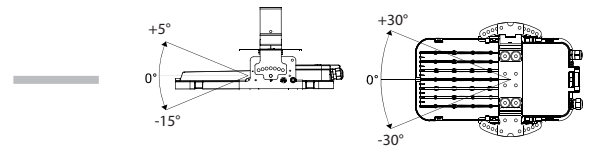

Bracket for duct installation

A = 75 / 100 mm
B = from 100 to 300 mm

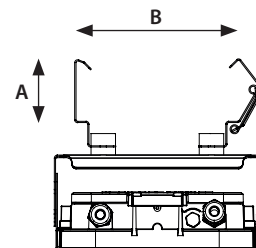

(*) Bracket dimensions and drilling are to be checked at the time of order.

Tarus Tunnel 600

Installation Tips

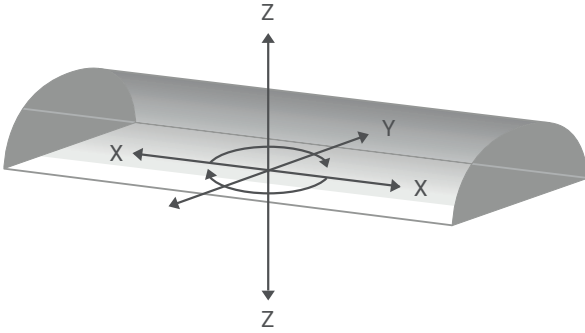

X AXIS - TT2 P

Central setup

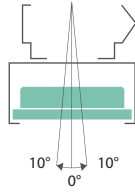

Arched tunnel



Squared tunnel

Side setup

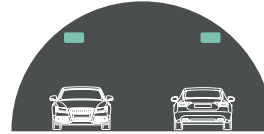
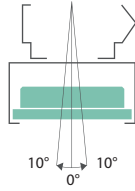

Arched tunnel



Squared tunnel

Bilateral setup

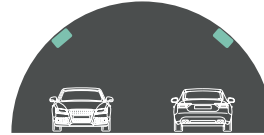

Arched tunnel



Squared tunnel

Y AXIS - TT2 C

Central setup, lateral and wall set up

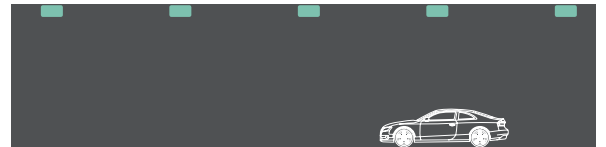
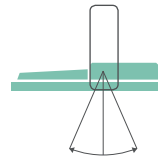

Z AXIS - TT2 C

Central setup

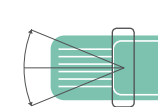

Bilateral setup

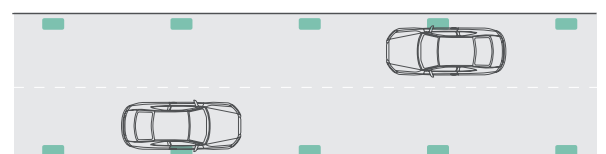
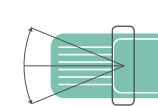

Bilateral wall setup

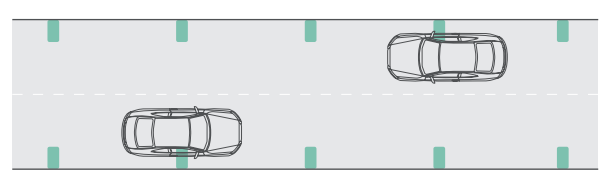
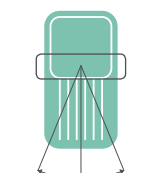

Tarus Tunnel 600

Available optical system

11A

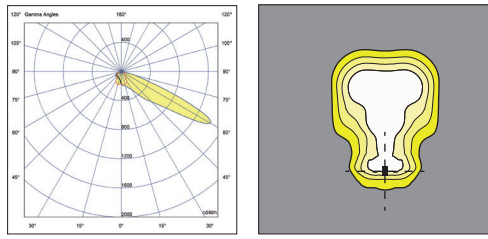

11E

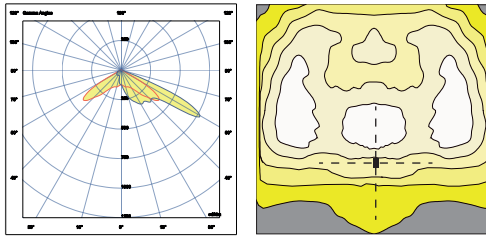

11F

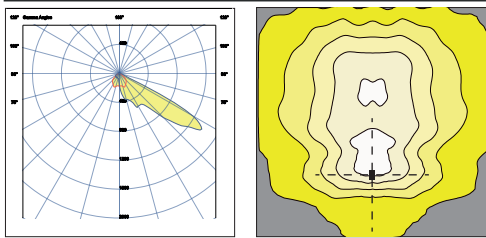

The LED modules nominal data refers only to the LED light sources in a standard version, with 4000 K color temperature, color rendering index CRI 70 min. and a junction temperature t_j of 77°F (25°C). The LED nominal data are extrapolated from the manufacturer documentations.

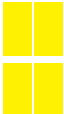
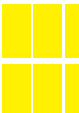
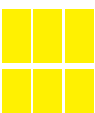
LED code		(*) I [mA]	Luminous flux [lm]	Power [W]	Efficiency [lm/W]
GL24		350	19600	93,4	210
		525	27814	143,1	194
		700	34949	194,1	180
GL32		350	25888	124,2	208
		525	36733	190,4	193
		700	46146	257,6	179
GL40		350	31746	154,6	205
		525	45034	236,4	190
		700	56549	320,2	177
GL48		350	37358	184,0	203
		525	52982	282,4	188
		700	66499	381,8	174

The lighting fixture measured data refers to GMR ENLIGHTS products in a standard version, with 4000 K color temperature, optica type 3B and an ambient temperature t_a of 77°F(25 °C).

GMR ENLIGHTS offers the possibility of driving the device with custom currents (*).

Feature availability is subject to configurations. To obtain luminous fluxes and efficiencies of the lighting fixture in case of optic type and/or color temperature and/or color rendering index different from the standard use the conversion factors shown in the tables.

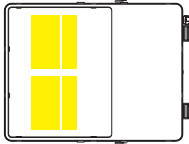
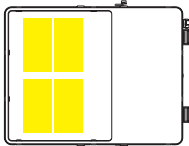
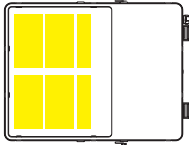
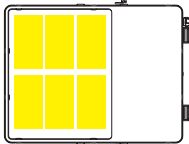
Order code: TT6 C_ GLxx	(*) I [mA]	Flusso luminoso [lm]	Potenza [W]	Efficienza [lm/W]
GL24 	350	17420	101,5	170
	525	24721	155,5	157
	700	31063	211,0	146
GL32 	350	23009	135,0	169
	525	32648	207,0	156
	700	41014	280,0	145
GL40 	350	28216	168,0	166
	525	40026	257,0	154
	700	50261	348,0	143
GL48 	350	33204	200,0	164
	525	47091	307,0	152
	700	59104	415,0	141

OPTIC CONVERSION FACTOR LUMINOUS FLUX

Optic type	Flux multiplier
1A 11C	1
1B 1C 1D 2A 2B	0,99
3A 3C 3D 3E 3F 3G 3H	0,99
4A 4B	0,98
5A 11D	1,01
11A 11B	1,00

Tk CONVERSION FACTOR LUMINOUS FLUX

Tk [K]	Flux multiplier
3.000	0,94
5.700	1,01

CRI CONVERSION FACTOR LUMINOUS FLUX

CRI (color render index)	Flux multiplier
70	1,00
80	0,93

(*) See pag: Available optical system, to check the optic type availability.
 (**) See pag: Technical data, to check the colour temperature availability.

Functions

Standard functionality

Fixed current

During production, the light fixture is pre-set with a fixed current amongst the standard settings that appear in the tables on page 3. Upon customer's request, it is also possible to set a specific current (custom setting).

Virtual Midnight | Automatic dimming

The driver is programmed to automatically dim the light output according to the time. As required by regulations, the maximum output is set during initial hours and towards the end of the light fixture's operating time interval. During these hours there is statistically more traffic. The light output is then dimmed during the central hours of the operating time interval. This management is achievable through a self-learning process of the device, that establishes the centre point of the time interval. This moment is called "virtual midnight" and it is the point that the dimming profile refers to in order to know when to reduce the light output. We can manage up to 8hrs of programming that evolve around the virtual midnight and up to 5 steps of dimming. This way the light output will adjust automatically, adapting throughout the year to the duration of the nighttime, by referring to the pre-set parameters based on the centre point of the operating time interval.

CLO Constant Lumen Output

LEDs over time are inevitably subject to performance depreciation. This light reduction may be compensated by gradually increasing the LED's current during its lifespan, this corresponds to a gradual increase of lumen output proportional to the amount that is naturally depreciated.

On request functionality

DALI - DALI2 Control and monitoring system

On request, the fixture can be fitted with a DALI2 communication interface. This protocol allows it to be monitored and controlled remotely through use of Dali control buses.

DALI SENSOR (D4i)

On request, the fixture can be equipped with a D4i certified power supply. This is the ideal solution for wireless sensors and/or controls. This system was developed to integrate various systems to address smart city requirements. Included is DALI2 protocol + auxiliary power (AUX) to supply power to devices and sensors. This system is usually required when using a Zhaga Lumawise socket.

LINESWITCH

This functionality by using an extra wire within the streetlight's power line, allows to dimmer to a pre-set level. For example, a centralised timer can change this value from 100% to 50%, and vice versa.

AMPDIM

This feature allows dimming using the power line controlled by an upstream flow regulator. For this feature, the flow controller must use amplitude modulation (AM).

NEMA | Nema Socket (7 PIN)

The Nema Socket is a 7 PIN connector/socket with IP66 rating, that is fitted on the fixture to make it interfaceable with various ANSI C136 compliant devices and remote-control gear. These devices can be installed during or after installation of the light fixtures. The NEMA socket can provide power interruption and is interfaceable with DALI buses and/or 1-10V dimming. It is compatible with point-to-point node connection, and twilight sensors ect.

ZHAGA Lumawise Zhaga Socket (4 PIN)

The Lumawise Zhaga socket is a small and compact 4 Pin connector/socket, that fits ideally with the design of GMR ENLIGHTS fixtures. With ZHAGA Lumawise sockets it is possible install the devices, sensors, ZHAGA remote controls during or after installation of the light fixtures. This socket is usually required in conjunction with the DALI Sensor feature, which involves a DALI2/D4i communication protocol in addition to 12/24V auxiliary port to supply power to the sensors. It is compatible with point-to-point wireless control solutions and SMART CITY applications to control and monitor the public lighting infrastructure.

REMOTE CONTROL ZHAGA STD

The device is installed on the lighting body equipped with D4i driver, via a prepared zhaga socket. The remote control works at 2.4GHz frequencies, and communicates in a secure mesh network thanks to 256bit data encryption. Thanks to the better positioning of the antenna, the node allows you to cover large distances and overcome obstacles. Equipped with lux meter and accelerometer, it can work both stand-alone and within the dedicated communication infrastructure. The device implements energy saving policies that bring the average consumption to 0.19W. In the smartcity application, the node allows you to interact with the street lighting network, dimming the lighting fixtures as needed and based on traffic and weather conditions, bringing significant economic advantages to the system in terms of energy savings. The node also allows monitoring and diagnostics of the public lighting network, from a single area, to the country up to an entire city or region. The knot has a diameter of 80mm and a height of 59mm. IK09, IP66.

ZHAGA GPS REMOTE CONTROL

In addition to the functionality expressed for the STD version, this version also includes a GPS. Thanks to GPS, the system can count on an astronomical clock as well as all the functions related to the exact positioning of the lighting body. Especially in the installation and commissioning phase, having the information relating to the positioning available simplifies and significantly speeds up the start-up of the system.

Third-party remote control

GMR ENLIGHTS fixtures are compatible with most third-party remote controls, powerline communication systems, wired systems (buses) and wireless systems.

Example of 4-step adjustment with virtual midnight

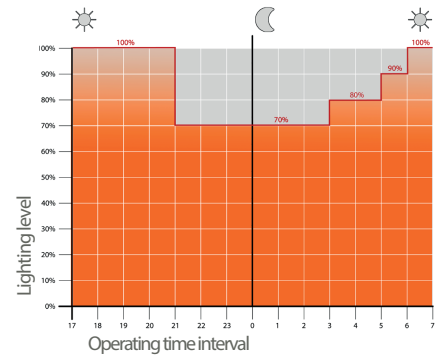

CLO Light Flow Compensation

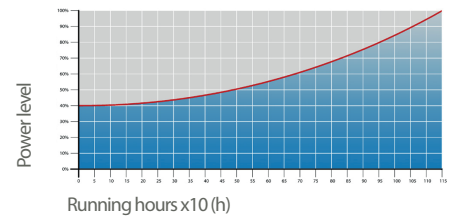

7 Pin Nema Socket 7 (A) and IP66 shorting cap (B)

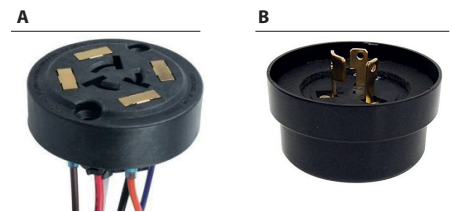

4 Pin Lumawise Zhaga Socket (C) and IP66 cap (D)

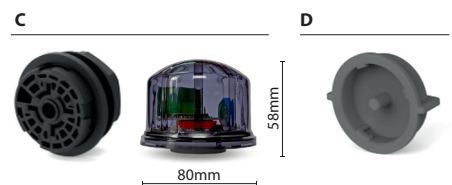

Installation example of Lumawise Zhaga



Protection cycles

GMR ENLIGHTS works with cast iron, steel and aluminum. The materials are selected and processed to maximize performance and quality.

GALVANIZED STEEL

Protection of galvanized steel surfaces for poles

The protection of galvanized steel elements is achieved by following steps:

- Micro sandblasting;
- First epoxy layer application followed by: Wilting > Drying > Cooling;
- Acrylic glaze layer application followed by: Wilting > Drying > Cooling;
- Packing at least after 24-hour-drying at room temperature.

Protection of galvanized steel surfaces for brackets and pastorals

The protection of the galvanized steel elements is achieved thanks to:

- Micro sandblasting;
- Phosphoric pickling bath at a ph level ranging from 1.5 to 3;
- Rinsing with demineralised water;
- First powder layer application;
- Kiln firing;
- Application of a final powder layer;
- Kiln roasting of the final powder layer at 356°F (180°C);
- Cooling.

CAST IRON

Protection of cast iron surfaces for bases

The protection of cast iron elements is achieved by the following treatments:

- Surface micro shotblasting;
- Mono-component dip galvanizing followed by: Wilting > Drying > Cooling;
- Epoxy micaceous primer application followed by: Wilting > Drying > Cooling;
- Acrylic enamel application followed by: Wilting > Drying > Cooling;
- Packing at least after 24-hour-drying at room temperature.

DIE-CAST ALUMINIUM

Protection of die-cast aluminium surfaces for lighting fixtures, tops, collars, brackets and pastorals

Lighting fixtures, brackets, pastoral, and die-cast accessories undergo a cycle of powder painting which creates a barrier against the corrosion of metal parts. Moreover this barrier makes the finished product comply with design specifications in terms of surface roughness, color and reflectance.

The cycle consists of the following steps:

- Micro sandblasting;
- Hot pickling bath in a zinc-based phosphodegreasing solution;
- Specific process for the preparation of surfaces before painting;
- Washing with water;
- Rinsing with demineralised water and subsequent drying;
- First powder layer application followed by kiln baking at 356°F (180°C);
- Final powder layer application using a High Durability product and final kiln roasting at 356°F (180°C).



Salt spray test

The top quality of such treatments is confirmed by salt spray tests performed in accordance with standard ISO 9227:2017 Neutral Salt Spray test (NSS).

The test was carried out for 8.000 hours at 95°F (35°C) and demonstrated through the report test released.



GMR ENLIGHTS s.r.l.

Legal headquarters:
Strada Provinciale Specchia - Alessano, 68 • 73040 (LE)

Administrative and operational headquarters:
Via Grande n°226 • 47032 Bertinoro (FC)

T +39 0543 462611
F +39 0543 449111

sales@gmrenlights.com
www.gmrenlights.com