



TARUS600

The pictures shown are for illustrative purposes only. For shape, material and color specifications refer to internal descriptions.

Tarus Sport 600

Technical data

INSTALL

Large areas, sports fields, sports facilities, industrial contexts.

ACCESSIBILITY



Openable

Openable fixture with basic tools
Replaceable internal components using basic tools.

OPTICAL TECHNOLOGY



Glassed

Refracting optical system consist of singlechip LED, PMMA lenses with 30 years of warranty against UV and yellowing by aging, aluminium reflector having a purity of 99,7% and extra clear tempered glass.

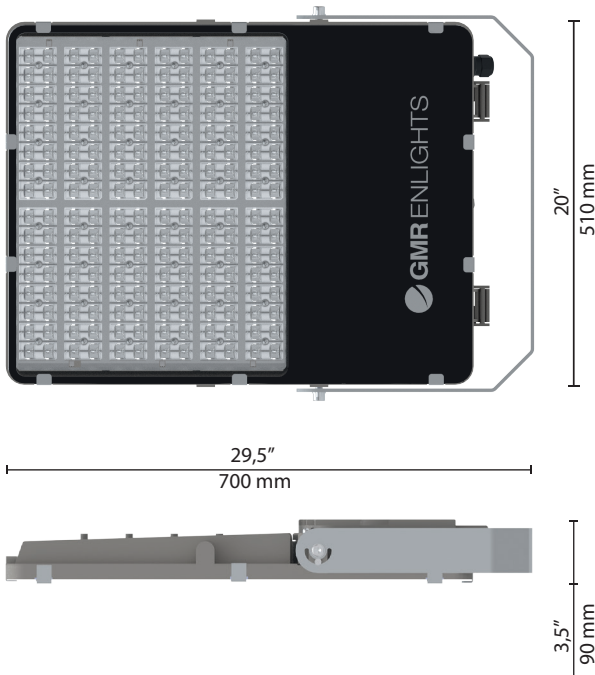

Scale: 1:15

Max. weight

48 lb (22 Kg)

EPA (CXS)

Front: 2,9ft² (0,27 m²)

STANDARD

Compliance: UL Standard 1598-CSA C22,2no.250.0.

CONFORMITY | PROTECTION

Conformity



Salt spray test

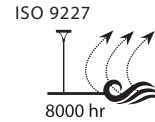

Vibration test passed

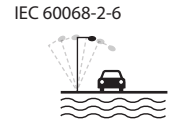

Safety classes



Protection classes



Photobiological safety



PLUS



LIGHTING FIXTURE FEATURES

General features

Power source:	120-277V 50/60Hz tolerance +/-10%
Current supply:	350 mA 525 mA 700 mA 1050 mA (P _{max} = 626W)
Power Factor THD:	≥0.95 <10 % (At full load)
Expected life (Ta=77°F 25°C):	> 100.000 h L90B10 @ LED 1050mA
Operational temperature (Ta):	T _{min} = -40°F (-40°C) T _{max} = 122°F (50°C) 1050 mA (324W)
Storage temperature:	-40°F/+176°F (-40°C/+80°C)
Overcharge protection:	Main surge immunity up to 10kV
Disconnecter:	Optional
Standard functions:	Current fixed Virtual midnight CLO

Materials

Lighting fixture:	Die cast aluminium EN1706
Optical system:	Optics in PMMA Aluminium reflector, 99,7% oxidised and polished purity
Screen:	Screen-printed ultraclear tempered glass Th. 0,15in (4mm)
Gaskets:	Removable silicon
Cable gland:	Polyamide PA66 PG16 Ø 0,55in (14mm) MAX
Screws and bolts:	AISI 304 stainless steel
Bracket:	Galvanized steel
Fixture color:	GMR light
Silkscreen color:	RAL 9005

LED FEATURES

LED data 4.000 K - 700mA:	340 lm/LED 180 lm/W 77°F (25°C) [Tj] ≤ 3 step MacAdam
Color temperature:	3.000 K 4.000 K 5.700 K CRI ≥ 70

FIXING TYPE*

5° step seamless tilt adjustment

Pole-top

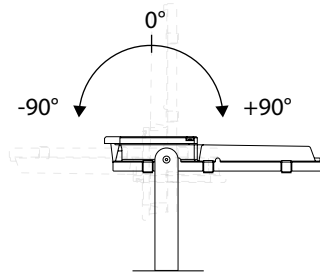

Wall mounting

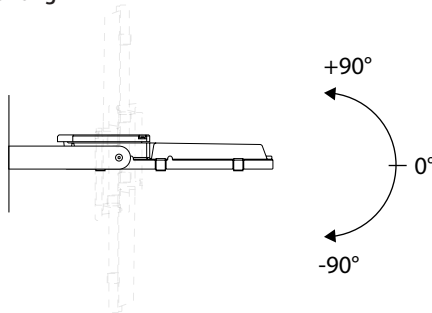

Surface mounting

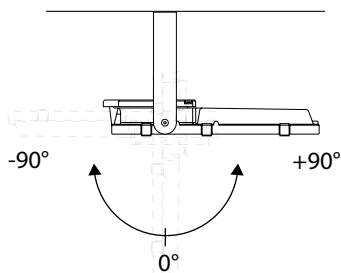

BRACKET DRILLING

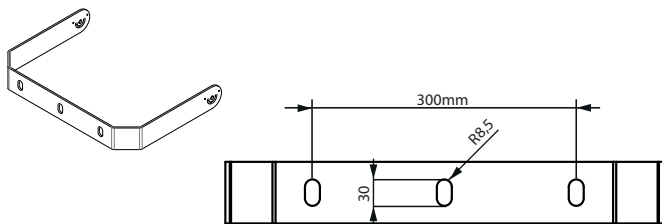

OPTIONAL

Mechanical equipment: Hot galvanized steel pole-top cross arm
Galvanized protection grid | Optical Aiming device

Additional surge protector device: SPD | Max peak current 10kV/5kA 8/20μs

Additional surge protector device SPD 400: SPD | Max peak current 10kV 8/20μs + permanent overvoltage protection higher than 270Vac

Electrical equipment: 1,64ft (0,5m) power cable with 2-3 or 4-5 core connector
Disconnecter and cable clamp | cross section AWG14 ÷ AWG6

Optional functions: DALI2 | D4i

Connectors and sockets: NM (Nema Socket) | ZS (Lumawise Zhaga Socket)

^(*)The icons are demonstrative. The actual dimensions and distances between the products are to be checked at time of order.

Tarus Sport 600

Available optical system

9A

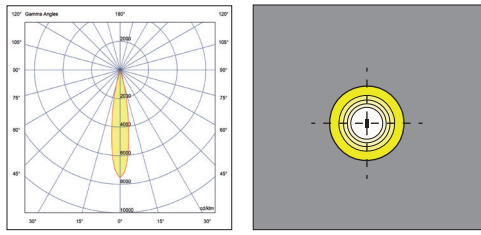

9B

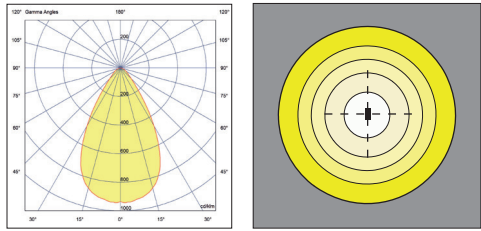

9C

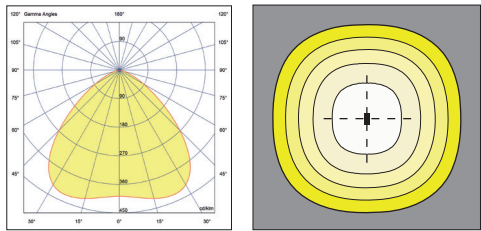

9E

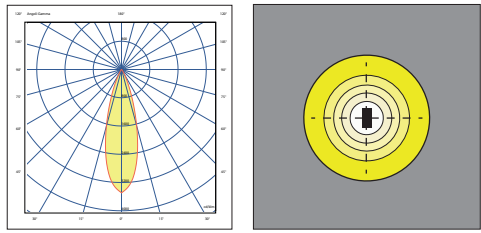

11A

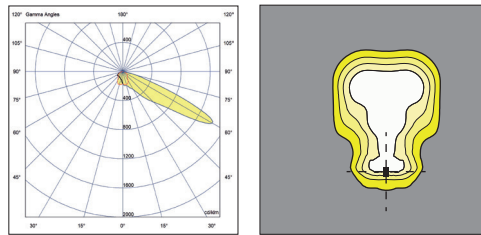

11B

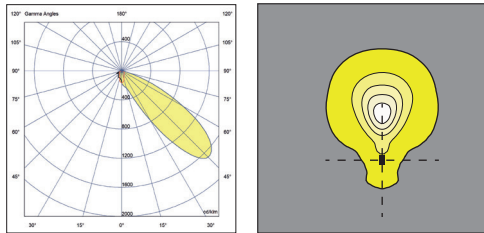

11E

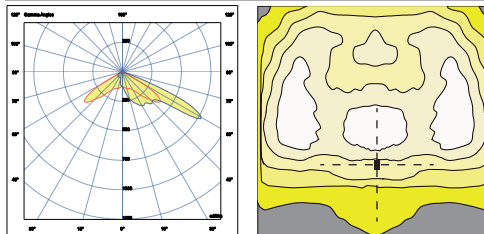

11F

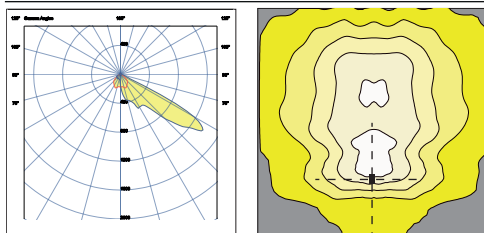

The LED modules nominal data refers only to the LED light sources in a standard version, with 4000 K color temperature, color rendering index CRI 70 min. and a junction temperature t_j of 77°F (25°C). The LED nominal data are extrapolated from the manufacturer documentations.

LED code		(*) I [mA]	Luminous flux [lm]	Power [W]	Efficiency [lm/W]
GL24		350	19795	93,4	212
		525	28092	143,1	196
		700	35299	194,1	182
		1050	48185	298,1	162
GL32		350	26147	124,2	211
		525	37100	190,4	195
		700	46607	257,6	181
		850	54244	316,5	171
		900	56828	336,7	169
		1000	61828	377,2	164
GL40		1050	62964	395,6	159
		350	32064	154,6	207
		525	45484	236,4	192
		700	57115	320,2	178
		750	60525	345,0	175
		800	63864	369,8	173
		850	66456	393,3	169
		900	69620	418,6	166
GL48		950	72716	443,9	164
		1000	74993	469,2	160
		350	37732	184,0	205
		525	53513	282,4	189
		600	58809	318,3	185
		650	63713	353,7	180
		700	67164	381,8	176
		750	71173	411,7	173
		800	75098	441,1	170
		900	80916	499,6	162
		950	84513	529,5	160
1000	88030	559,8	157		
		1050	90517	575,9	157

The lighting fixture measured data refers to GMR ENLIGHTS products in a standard version, with 4000 K color temperature, optica type 9A and an ambient temperature t_a of 77°F(25 °C).

GMR ENLIGHTS offers the possibility of driving the device with custom currents (°).

Feature availability is subject to configurations. To obtain luminous fluxes and efficiencies of the lighting fixture in case of optic type and/or color temperature and/or color rendering index different from the standard use the conversion factors shown in the tables.

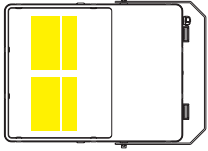
Order code: TS6_GLxx	(°) I [mA]	Luminous flux [lm]	Power [W]	Efficiency [lm/W]
GL24 	350	17420	101,5	168
	525	24721	155,5	156
	700	31063	211,0	144
	1050	42403	324,0	128
GL32 	350	23009	135,0	170
	525	32648	207,0	158
	700	41014	280,0	146
	850	47735	344,0	139
	900	50009	366,0	137
	1000	54409	410,0	133
GL40 	350	28216	168,0	168
	525	40026	257,0	156
	700	50261	348,0	144
	750	53262	375,0	142
	800	56200	402,0	140
	850	58481	427,5	137
	900	61266	455,0	135
	950	63990	482,5	133
GL48 	1000	66654	510,0	130
	350	33204	200,0	166
	525	47091	307,0	153
	600	51752	346,0	150
	650	56067	384,5	146
	700	59104	415,0	142
	750	62632	447,5	140
	800	66086	479,5	138
	900	71206	543,0	131
	950	74371	575,5	129
	1000	77466	608,5	127
	1050	79655	626,0	127

OPTIC CONVERSION FACTOR LUMINOUS FLUX

Optic type	Flux multiplier
11A 11B 11E 11F	0,98
9A 9E	1,00
9B 9C 11C	0,99

Tk CONVERSION FACTOR LUMINOUS FLUX

Tk [K]	Flux multiplier
3.000	0,94
5.700	1,01

CRI CONVERSION FACTOR LUMINOUS FLUX

CRI (color render index)	Flux multiplier
70	1,00
80	0,93

Below are the limitations based on the ambient temperatures for correct and safe use of the Tarus 600 projector divided by geographical area. Please always refer to the table and discuss with the reference sales office when ordering.

AVERAGE TA IN THE HOTTEST MONTH (°C)							
America		Asia/Oceania		Middle East/Africa		Europe	
	ToP		ToP		ToP		ToP
Argentina	30	Australia	30	Saudi Arabia	45	Albania	30
Brazil	30	South Korea	30	Bahrain	40	Austria	25
Canada	25	Philippines	35	Egypt	35	Belgium	25
Chile	30	Hong Kong	35	Jordan	35	Bosnia Herzegovina	35
Colombia	20	India	35	Israel	30	Bulgaria	30
Ecuador	30	Iran	35	Kuwait	50	Cyprus	35
Mexico	30	Malaysia	35	Libanon	30	Croatia	30
Perù	30	New Zealand	25	Morocco	30	Denmark	20
Uruguay	35	Pakistan	35	Oman	40	Estonia	20
USA (Arizona)	40	Russia	25	Qatar	45	Finland	20
USA (New York)	30	Singapore	35	UAE (Abu Dhabi)	40	France (Lyon)	30
		Taiwan	35			France (Marseille)	30
		Vietnam	35			France (Parigi)	25
						Germany	25
						Greece	35
						Ireland	20
						Iceland	15
						Canary Islands	30
						Italy	30
						Lettonia	20
						Liechtenstein	25
						Lithuania	25
						Luxembourg	25
						Malta	35
						Moldavia	30
						North Macedonia	30
						Norway	20
						Netherlands	20
						Poland	25
						Portugal	30
						Czech Republic	25
						Romania	30
						Scotland	20
						Serbia	30
						Slovenia	30
						Spain (Madrid)	35
						Spain (Malaga)	30
						Spain (Barcelona)	35
						Sweden (Goteborg)	20
						Sweden (Borlänge)	25
						Switzerland	25
						Turkey (Ankara)	30
						Ukraine (Kiev)	25
						UK	20

TARUS 600 OUTDOOR							
Max Current for optical configuration	ToP20	ToP25	ToP30	ToP35	ToP40	ToP45	ToP50
GL24	1050	1050	1050	1050	1050	1050	1050
GL32	1050	1050	1050	1050	1050	1050	900
GL40	1000	1000	1000	950	900	850	750
GL48	1050	1000	950	900	800	700	650

TARUS 600 INDOOR						
Max Current for optical configuration	ToP25	ToP30	ToP35	ToP40	ToP45	ToP50
GL24	1050	1050	1050	1050	1050	1050
GL32	1050	1050	1050	1050	1000	850
GL40	1000	1000	900	850	800	700
GL48	950	900	800	750	650	600

Functions

Standard functionality

Fixed current

During production, the light fixture is pre-set with a fixed current amongst the standard settings that appear in the tables on page 3. Upon customer's request, it is also possible to set a specific current (custom setting).

Virtual Midnight | Automatic dimming

The driver is programmed to automatically dim the light output according to the time. As required by regulations, the maximum output is set during initial hours and towards the end of the light fixture's operating time interval. During these hours there is statistically more traffic. The light output is then dimmed during the central hours of the operating time interval. This management is achievable through a self-learning process of the device, that establishes the centre point of the time interval. This moment is called "virtual midnight" and it is the point that the dimming profile refers to in order to know when to reduce the light output. We can manage up to 8hrs of programming that evolve around the virtual midnight and up to 5 steps of dimming. This way the light output will adjust automatically, adapting throughout the year to the duration of the nighttime, by referring to the pre-set parameters based on the centre point of the operating time interval.

CLO Constant Lumen Output

LEDs over time are inevitably subject to performance depreciation. This light reduction may be compensated by gradually increasing the LED's current during its lifespan, this corresponds to a gradual increase of lumen output proportional to the amount that is naturally depreciated.

On request functionality

DALI - DALI2 Control and monitoring system

On request, the fixture can be fitted with a DALI2 communication interface. This protocol allows it to be monitored and controlled remotely through use of Dali control buses.

DALI SENSOR (D4i)

On request, the fixture can be equipped with a D4i certified power supply. This is the ideal solution for wireless sensors and/or controls. This system was developed to integrate various systems to address smart city requirements. Included is DALI2 protocol + auxiliary power (AUX) to supply power to devices and sensors. This system is usually required when using a Zhaga Lumawise socket.

LINESWITCH

This functionality by using an extra wire within the streetlight's power line, allows to dimmer to a pre-set level. For example, a centralised timer can change this value from 100% to 50%, and vice versa.

AMPDIM

This feature allows dimming using the power line controlled by an upstream flow regulator. For this feature, the flow controller must use amplitude modulation (AM).

NEMA | Nema Socket (7 PIN)

The Nema Socket is a 7 PIN connector/socket with IP66 rating, that is fitted on the fixture to make it interfaceable with various ANSI C136 compliant devices and remote-control gear. These devices can be installed during or after installation of the light fixtures. The NEMA socket can provide power interruption and is interfaceable with DALI buses and/or 1-10V dimming. It is compatible with point-to-point node connection, and twilight sensors ect.

ZHAGA Lumawise Zhaga Socket (4 PIN)

The Lumawise Zhaga socket is a small and compact 4 Pin connector/socket, that fits ideally with the design of GMR ENLIGHTS fixtures. With ZHAGA Lumawise sockets it is possible install the devices, sensors, ZHAGA remote controls during or after installation of the light fixtures. This socket is usually required in conjunction with the DALI Sensor feature, which involves a DALI2/D4i communication protocol in addition to 12/24V auxiliary port to supply power to the sensors. It is compatible with point-to-point wireless control solutions and SMART CITY applications to control and monitor the public lighting infrastructure.

REMOTE CONTROL ZHAGA STD

The device is installed on the lighting body equipped with D4i driver, via a prepared zhaga socket. The remote control works at 2.4GHz frequencies, and communicates in a secure mesh network thanks to 256bit data encryption. Thanks to the better positioning of the antenna, the node allows you to cover large distances and overcome obstacles. Equipped with lux meter and accelerometer, it can work both stand-alone and within the dedicated communication infrastructure. The device implements energy saving policies that bring the average consumption to 0.19W. In the smartcity application, the node allows you to interact with the street lighting network, dimming the lighting fixtures as needed and based on traffic and weather conditions, bringing significant economic advantages to the system in terms of energy savings. The node also allows monitoring and diagnostics of the public lighting network, from a single area, to the country up to an entire city or region. The knot has a diameter of 80mm and a height of 59mm. IK09, IP66.

ZHAGA GPS REMOTE CONTROL

In addition to the functionality expressed for the STD version, this version also includes a GPS. Thanks to GPS, the system can count on an astronomical clock as well as all the functions related to the exact positioning of the lighting body. Especially in the installation and commissioning phase, having the information relating to the positioning available simplifies and significantly speeds up the start-up of the system.

Third-party remote control

GMR ENLIGHTS fixtures are compatible with most third-party remote controls, powerline communication systems, wired systems (buses) and wireless systems.

Example of 4-step adjustment with virtual midnight

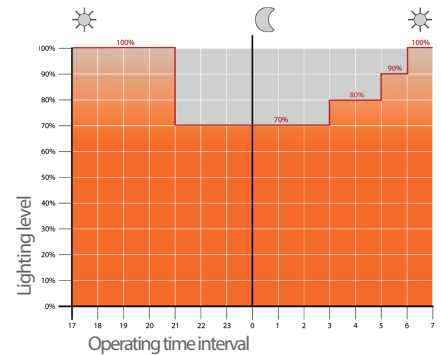

CLO Light Flow Compensation

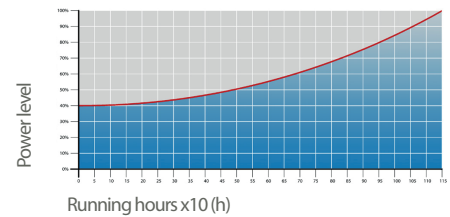

7 Pin Nema Socket 7 (A) and IP66 shorting cap (B)

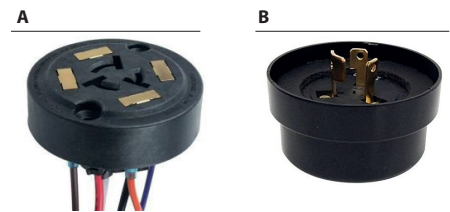

4 Pin Lumawise Zhaga Socket (C) and IP66 cap (D)

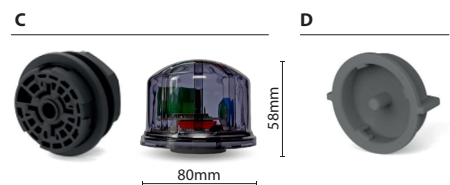

Installation example of Lumawise Zhaga



Protection cycles

GMR ENLIGHTS works with cast iron, steel and aluminum. The materials are selected and processed to maximize performance and quality.

GALVANIZED STEEL

Protection of galvanized steel surfaces for poles

The protection of galvanized steel elements is achieved by following steps:

- Micro sandblasting;
- First epoxy layer application followed by: Wilting > Drying > Cooling;
- Acrylic glaze layer application followed by: Wilting > Drying > Cooling;
- Packing at least after 24-hour-drying at room temperature.

Protection of galvanized steel surfaces for brackets and pastorals

The protection of the galvanized steel elements is achieved thanks to:

- Micro sandblasting;
- Phosphoric pickling bath at a ph level ranging from 1.5 to 3;
- Rinsing with demineralised water;
- First powder layer application;
- Kiln firing;
- Application of a final powder layer;
- Kiln roasting of the final powder layer at 356°F (180°C);
- Cooling.

CAST IRON

Protection of cast iron surfaces for bases

The protection of cast iron elements is achieved by the following treatments:

- Surface micro shotblasting;
- Mono-component dip galvanizing followed by: Wilting > Drying > Cooling;
- Epoxy micaceous primer application followed by: Wilting > Drying > Cooling;
- Acrylic enamel application followed by: Wilting > Drying > Cooling;
- Packing at least after 24-hour-drying at room temperature.

DIE-CAST ALUMINIUM

Protection of die-cast aluminium surfaces for lighting fixtures, tops, collars, brackets and pastorals

Lighting fixtures, brackets, pastoral, and die-cast accessories undergo a cycle of powder painting which creates a barrier against the corrosion of metal parts. Moreover this barrier makes the finished product comply with design specifications in terms of surface roughness, color and reflectance.

The cycle consists of the following steps:

- Micro sandblasting;
- Hot pickling bath in a zinc-based phosphodegreasing solution;
- Specific process for the preparation of surfaces before painting;
- Washing with water;
- Rinsing with demineralised water and subsequent drying;
- First powder layer application followed by kiln baking at 356°F (180°C);
- Final powder layer application using a High Durability product and final kiln roasting at 356°F (180°C).



Salt spray test

The top quality of such treatments is confirmed by salt spray tests performed in accordance with standard ISO 9227:2017 Neutral Salt Spray test (NSS).

The test was carried out for 8.000 hours at 95°F (35°C) and demonstrated through the report test released.



GMR ENLIGHTS s.r.l.

Legal headquarters:
Strada Provinciale Specchia - Alessano, 68 • 73040 (LE)

Administrative and operational headquarters:
Via Grande n°226 • 47032 Bertinoro (FC)

T +39 0543 462611
F +39 0543 449111

sales@gmrenlights.com
www.gmrenlights.com