



# **GAMMA**smallA

*The pictures shown are for illustrative purposes only. For shape, material and color specifications refer to internal descriptions.*

## Available versions

rev. 2023.10

The classic lighting fixtures can be equipped with a die-cast aluminum decorative ring.

The decorative ring has a purely aesthetic value.

Below are the models of the lighting fixture with and without this option and the relative coding.



Without decorative ring version  
Product code: GAMS S\_GFxx\_A

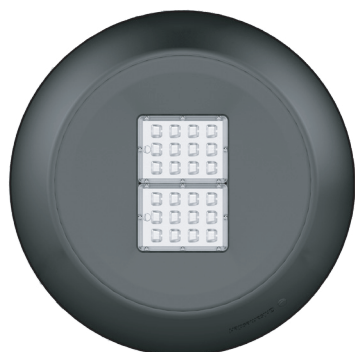
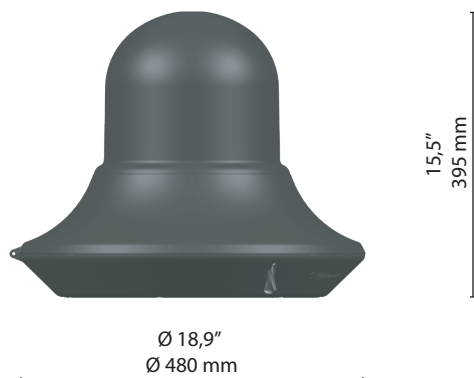

With decorative ring version  
Product code: GAMS F\_GFxx\_A

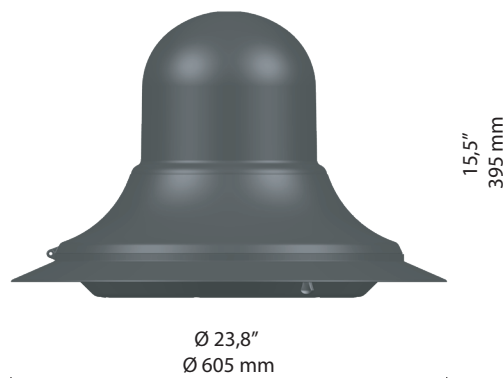

Scale: 1:10

### ACCESSIBILITY



#### Timeless

Tool-free openable fixture. Replaceable internal components without the need of tools.

### OPTICAL TECHNOLOGY



#### Glass free

Refracting optical system consist of single-chip LED, shockproof lenses with 30 years of warranty against UV and yellowing by aging (GLASS-FREE).

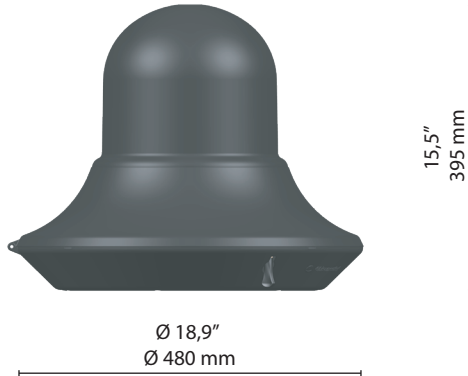

Scale: 1:10

#### Max. weight

18 lb (8,2 Kg)

fixing device excluded

#### EPA (CXS)

Plan: 2,2 ft<sup>2</sup> (0,21 m<sup>2</sup>)

### FIXING TYPE



#### Suspended

Fast connection | Ø3/4" Gas

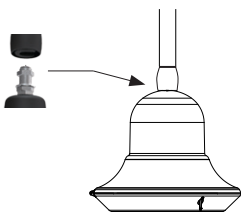

#### Wire system

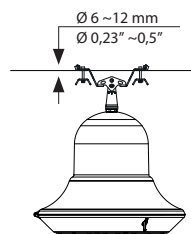

### OPTIONAL

#### Glass

Ultraclear tempered glass  
Th. 0,15in (4mm)

1,7 lb  
0,8 Kg

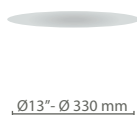

#### Diffusers

Polycarbonate with U.V. protection

#### Alba

1,1 lb  
0,5 Kg

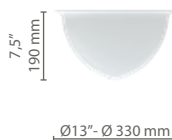

#### Tonda

0,88 lb  
0,4 Kg



1,6 lb  
0,72 Kg



### STANDARD

Compliance: UL Standard 1598-CSA C22,2no.250.0.

### CONFORMITY | PROTECTION

#### Conformity



#### Salt spray test

ISO 9227



#### Safety classes



Class I

#### Protection classes



#### Photobiological safety



Classe 0 Exempt group IEC/TR62471

### PLUS



DARK SKY FRIENDLY



OPTICAL FLEXIBILITY



LOW GLARE



COMPLIANT

### LIGHTING FIXTURE FEATURES

#### General features

Power source:	120-277V   50/60Hz   tolerance +/-10%
Current supply:	350 mA   525 mA   700 mA   1050 mA (P <sub>max</sub> = 78W)
Power Factor   THD:	≥0.95   <10 % (At full load)
Expected life (Ta=77°F 25°C):	> 100.000 h   L90B10
Operational temperature (Ta):	T <sub>min</sub> = -40°F (-40°C)   T <sub>max</sub> = 131°F (55°C)   700 mA 104°F (40°C)   1050 mA
Storage temperature:	-40°F/+176°F (-40°C/+80°C)
Overcharge protection:	Main surge immunity up to 10kV
Disconnecter:	Disconnecter and cable clamp   cross section AWG14 ÷ AWG6
Standard functions:	Current fixed   Virtual midnight   CLO

#### Materials

Lighting fixture:	Die cast aluminium   EN1706
Optical system:	Optics in PMMA
Gaskets:	Removable silicon
Cable gland:	Polyamide PA66   PG16   Ø 0,55in (14mm) MAX
Screws and bolts:	AISI 304 stainless steel
Fixture color:	GMR dark   Others on request
Diffusers color:	Transparent   Frosted

### LED FEATURES

LED data 4.000 K - 640mA:	700 lm/LED   181 lm/W   25°C [Tj]   ≤ 3 step MacAdam
Color temperature:	2.200 K   3.000 K   4.000 K   CRI ≥ 70

#### Additional surge protector device:

SPD | Max peak current 10kV

8/20µs

#### Additional surge protector device SPD 400:

SPD | Max peak current 10kV 8/20µs + permanent overvoltage protection higher than 270Vac

#### Optional functions:

1,64ft (0,5m) power cable with 2-3 or 4-5 core connector

#### Funzionalità su richiesta:

DALI2 | D4i

#### Connectors and sockets:

NM (Nema Socket) | ZS (Lumawise Zhaga Socket)

# Gamma small A

## Available optical system

### SYMMETRICAL DISTRIBUTION\\

1A

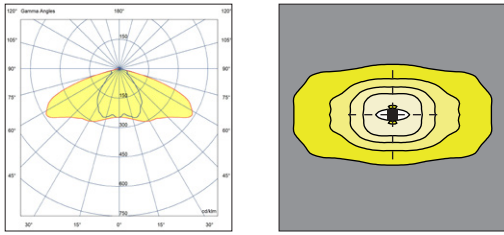

3C

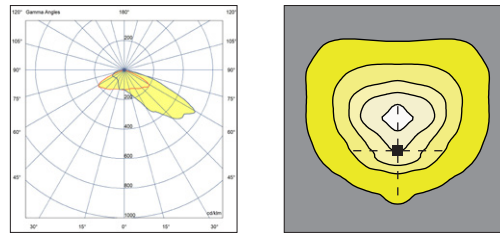

TYPE 1A

### ASYMMETRICAL DISTRIBUTION\\

2A

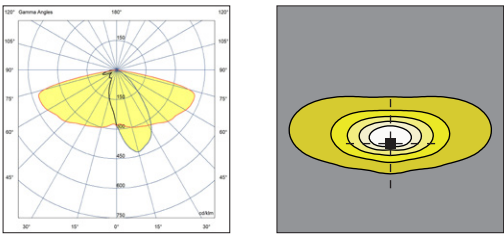

3D

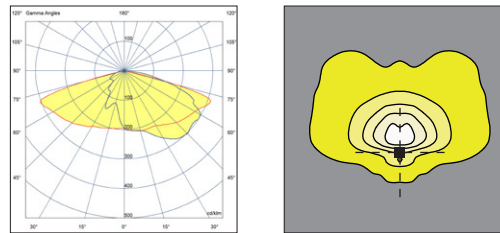

TYPE 2A

2B

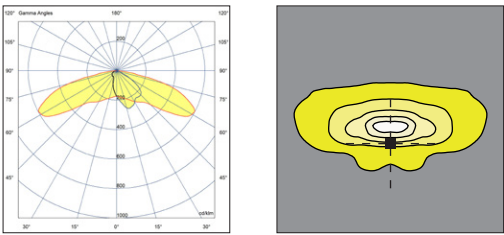

### SYMMETRICAL DISTRIBUTION\\

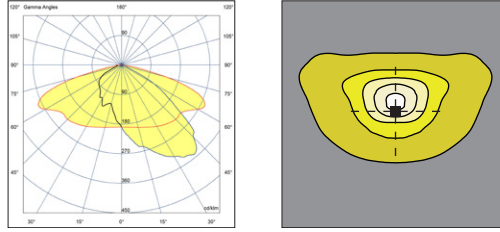

TYPE 3A | TYPE 3B

2C

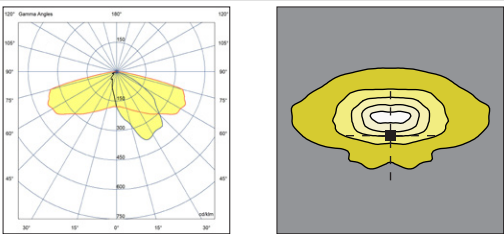

5A

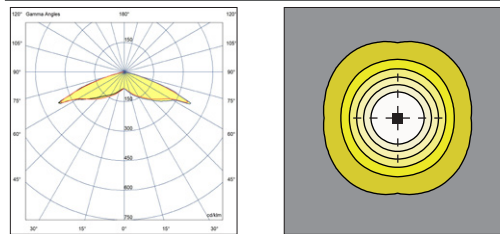

TYPE 5A

### ASYMMETRICAL DISTRIBUTION\\

3A

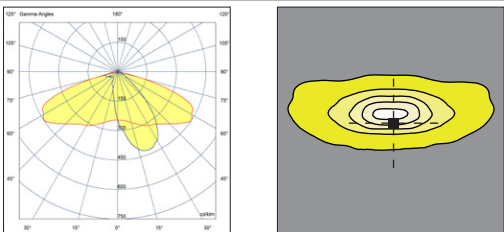

3B

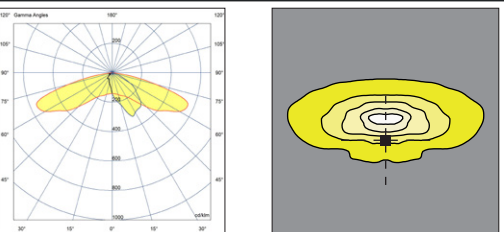

The LED modules nominal data refers only to the LED light sources in a standard version, with 4000 K color temperature, color rendering index CRI 70 min. and a junction temperature  $t_j$  of 77°F (25°C). The LED nominal data are extrapolated from the manufacturer documentations.

LED code	(*) I [mA]	Luminous flux [lm]	LED Power [W]	Efficiency [lm/W]
GF02	350	1639	7,7	214
	525	2453	11,7	209
	700	3195	15,9	201
	1050	4636	24,5	189
GF03	350	2413	11,5	210
	525	3537	17,6	201
	700	4599	23,8	193
	1050	6652	36,7	181
GF04	350	3156	15,3	206
	525	4621	23,4	198
	700	6089	31,7	192
	1050	8534	48,8	175
GF06	350	4659	22,9	204
	525	6854	35,0	196
	700	8692	47,4	183
	1050	11770	72,8	162

The lighting fixture measured data refers to GMR ENLIGHTS products in a standard version, with 4000 K color temperature and an ambient temperature  $t_a$  of 77°F (25°C).

**GMR ENLIGHTS offers the possibility of driving the device with custom currents (\*)**.

In case of optional glass some LED codes may be different from those indicated (GL02, GL04, GL06). In this case the values of luminous flux and efficiency are different from those shown in the table.

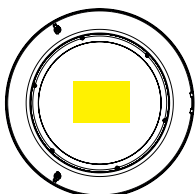
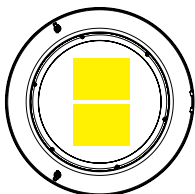
Order code: GAMS S_GFxx_A GAMS F_GFxx_A	(*) I [mA]	Luminous flux [lm]	LED Power [W]	Efficiency [lm/W]
<b>GF02</b> 	350	1580	9,0	176
	525	2364	13,5	175
	700	3080	18,5	167
	1050	4469	28,0	160
<b>GF03</b> 	350	2326	13,5	172
	525	3409	20,5	166
	700	4434	27,0	164
	1050	6412	40,5	158
<b>GF04</b> 	350	3042	17,5	174
	525	4454	26,5	168
	700	5870	35,0	168
	1050	8227	53,0	155
<b>GF06</b> 	350	4492	26,0	173
	525	6608	38,5	172
	700	8379	51,5	163
	1050	11346	78,5	145

### Tk CONVERSION FACTOR LUMINOUS FLUX

Tk [K]	Flux multiplier
2.200	0,86
3.000	0,95

### CRI CONVERSION FACTOR LUMINOUS FLUX

CRI (color render index)	Flux multiplier
70	1,00
80	0,91

(\*) See pag: Available optical system, to check the optic type availability.

(\*\*) See pag: Technical data, to check the colour temperature availability.

# Functions

## Standard functionality

### Fixed current

During production, the light fixture is pre-set with a fixed current amongst the standard settings that appear in the tables on page 3. Upon customer's request, it is also possible to set a specific current (custom setting).

### Virtual Midnight | Automatic dimming

The driver is programmed to automatically dim the light output according to the time. As required by regulations, the maximum output is set during initial hours and towards the end of the light fixture's operating time interval. During these hours there is statistically more traffic. The light output is then dimmed during the central hours of the operating time interval. This management is achievable through a self-learning process of the device, that establishes the centre point of the time interval. This moment is called "virtual midnight" and it is the point that the dimming profile refers to in order to know when to reduce the light output. We can manage up to 8hrs of programming that evolve around the virtual midnight and up to 5 steps of dimming. This way the light output will adjust automatically, adapting throughout the year to the duration of the nighttime, by referring to the pre-set parameters based on the centre point of the operating time interval.

### CLO Constant Lumen Output

LEDs over time are inevitably subject to performance depreciation. This light reduction may be compensated by gradually increasing the LED's current during its lifespan, this corresponds to a gradual increase of lumen output proportional to the amount that is naturally depreciated.

## On request functionality

### DALI2 Control and monitoring system

On request, the fixture can be fitted with a DALI2 communication interface. This protocol allows it to be monitored and controlled remotely through use of Dali control buses.

### D4i

On request, the fixture can be equipped with a D4i certified power supply. This is the ideal solution for wireless sensors and/or controls. This system was developed to integrate various systems to address smart city requirements. Included is DALI2 protocol + auxiliary power (AUX) to supply power to devices and sensors. This system is usually required when using a Zhaga Lumawise socket.

### LINESWITCH

This functionality by using an extra wire within the streetlight's power line, allows to dimmer to a pre-set level. For example, a centralised timer can change this value from 100% to 50%, and vice versa.

### AMPDIM

This feature allows dimming using the power line controlled by an upstream flow regulator. For this feature, the flow controller must use amplitude modulation (AM).

### NEMA | Nema Socket (7 PIN)

The Nema Socket is a 7 PIN connector/socket with IP66 rating, that is fitted on the fixture to make it interfaceable with various ANSI C136 compliant devices and remote-control gear. These devices can be installed during or after installation of the light fixtures. The NEMA socket can provide power interruption and is interfaceable with DALI buses and/or 1-10V dimming. It is compatible with point-to-point node connection, and twilight sensors etc.

### ZHAGA Lumawise Zhaga Socket (4 PIN)

The Lumawise Zhaga socket is a small and compact 4 Pin connector/socket, that fits ideally with the design of GMR ENLIGHTS fixtures. With ZHAGA Lumawise sockets it is possible install the devices, sensors, ZHAGA remote controls during or after installation of the light fixtures. This socket is usually required in conjunction with the DALI Sensor feature, which involves a DALI2/D4i communication protocol in addition to 12/24V auxiliary port to supply power to the sensors. It is compatible with point-to-point wireless control solutions and SMART CITY applications to control and monitor the public lighting infrastructure.

### PRESENCE SENSOR

The product can be equipped with a presence sensor type zhaga book 18 in the lower part of the luminaire. In this case the lighting body is provided with Zhaga socket and Driver D4i. It is very important to carefully evaluate the installation context (height and underlying area) according to the sensing diagram of the device.

### Third-party remote control

GMR ENLIGHTS fixtures are compatible with most third-party remote controls, powerline communication systems, wired systems (buses) and wireless systems.

### Example of 4-step adjustment with virtual midnight

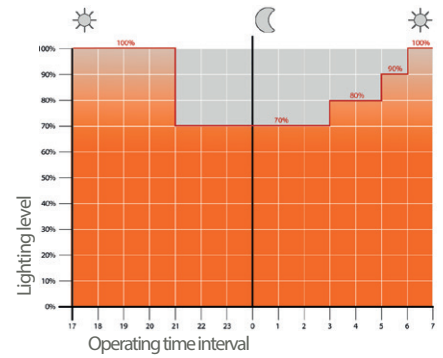

### CLO Light Flow Compensation

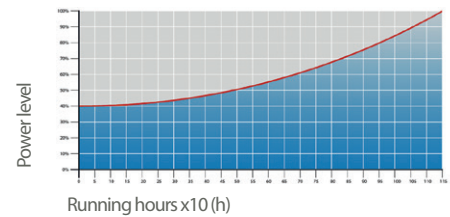

### 7 Pin Nema Socket 7 (A) and IP66 shorting cap (B)

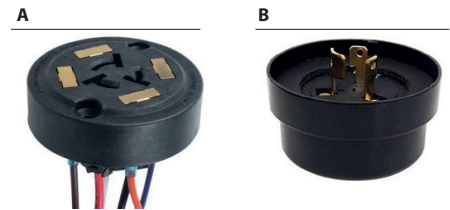

### 4 Pin Lumawise Zhaga Socket (C) and IP66 cap (D)

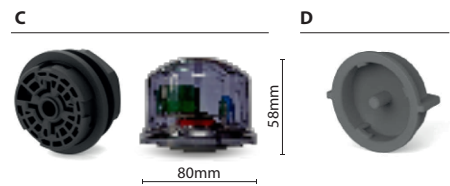

### Installation example of Lumawise Zhaga



### Installation example of presence sensor

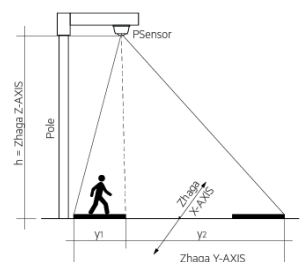

## Protection cycles

GMR ENLIGHTS works with cast iron, steel and aluminum. The materials are selected and processed to maximize performance and quality.

### GALVANIZED STEEL

#### Protection of galvanized steel surfaces for poles

The protection of galvanized steel elements is achieved by following steps:

- Micro sandblasting;
- First epoxy layer application followed by: Wilting > Drying > Cooling;
- Acrylic glaze layer application followed by: Wilting > Drying > Cooling;
- Packing at least after 24-hour-drying at room temperature.

#### Protection of galvanized steel surfaces for brackets and pastorals

The protection of the galvanized steel elements is achieved thanks to:

- Micro sandblasting;
- Phosphoric pickling bath at a ph level ranging from 1.5 to 3;
- Rinsing with demineralised water;
- First powder layer application;
- Kiln firing;
- Application of a final powder layer;
- Kiln roasting of the final powder layer at 356°F (180°C);
- Cooling.

### CAST IRON

#### Protection of cast iron surfaces for bases

The protection of cast iron elements is achieved by the following treatments:

- Surface micro shotblasting;
- Mono-component dip galvanizing followed by: Wilting > Drying > Cooling;
- Epoxy micaceous primer application followed by: Wilting > Drying > Cooling;
- Acrylic enamel application followed by: Wilting > Drying > Cooling;
- Packing at least after 24-hour-drying at room temperature.

### DIE-CAST ALUMINIUM

#### Protection of die-cast aluminium surfaces for lighting fixtures, tops, collars, brackets and pastorals

Lighting fixtures, brackets, pastoral, and die-cast accessories undergo a cycle of powder painting which creates a barrier against the corrosion of metal parts. Moreover this barrier makes the finished product comply with design specifications in terms of surface roughness, color and reflectance.

The cycle consists of the following steps:

- Micro sandblasting;
- Hot pickling bath in a zinc-based phosphodegreasing solution;
- Specific process for the preparation of surfaces before painting;
- Washing with water;
- Rinsing with demineralised water and subsequent drying;
- First powder layer application followed by kiln baking at 356°F (180°C);
- Final powder layer application using a High Durability product and final kiln roasting at 356°F (180°C).



#### Salt spray test

The top quality of such treatments is confirmed by salt spray tests performed in accordance with standard ISO 9227:2017 Neutral Salt Spray test (NSS).

The test was carried out for 8.000 hours at 95°F (35°C) and demonstrated through the report test released.



**GMR ENLIGHTS s.r.l.**

Legal headquarters:  
Strada Provinciale Specchia - Alessano, 68 • 73040 (LE)

Administrative and operational headquarters:  
Via Grande n°226 • 47032 Bertinoro (FC)

T +39 0543 462611  
F +39 0543 449111

[sales@gmrenlights.com](mailto:sales@gmrenlights.com)  
[www.gmrenlights.com](http://www.gmrenlights.com)