

Tarus Tunnel200

Tarus Tunnel 200

Technical data

INSTALL

Road tunnels

ACCESSIBILITY



Openable

Openable fixture with basic tools
Replaceable internal components
using basic tools.

OPTICAL TECHNOLOGY



Glassed

Refracting optical system consist of
singlechip LED, PMMA lenses with
30 years of warranty against UV
and yellowing by aging, aluminium
reflector having a purity of 99,7% and
extra clear tempered glass.

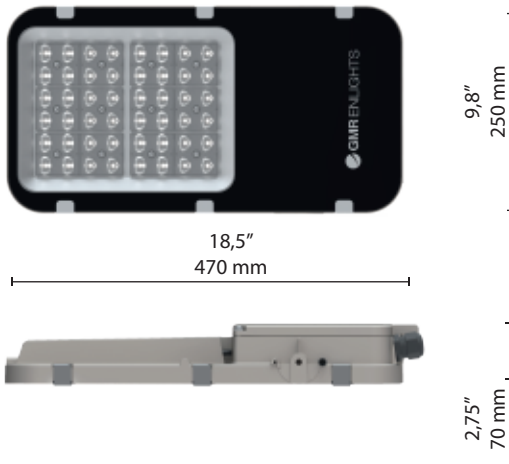

Scale: 1:10

Max. weight

5,5 Kg

CXS

Front: 0,1 m²

STANDARD

EN 60598-1, EN 60598-2-3, EN 62471, EN 55015, EN 61547, EN 61000-3-2, EN 61000-3-3

CONFORMITY | PROTECTION

Conformity



Salt spray test

ISO 9227



Vibration test passed

IEC 60068-2-6



Insulation classes



Protection classes



Photobiological safety



Classe 0 Exempt
group IEC/TR62471

PLUS



CUT OFF



OPTICAL
FLEXIBILITY



LOW GLARE



CAM
2017
COMPLIANT



A++
IPEA MIN

LIGHTING FIXTURE FEATURES

General features

Power source:	220-240V 50/60Hz tolerance +/-10%
	120-277V 50/60Hz tolerance +/-10%
Current supply:	525 mA 700 mA 1050 mA (P _{max} = 146,5W)
Power Factor THD:	≥0.95 <10 % (At full load)
Expected life (Ta=25°):	> 100.000 h L90B10 @ LED 1050mA
Operational temperature (Ta):	T _{min} = -40°C T _{max} = +55°C 700 mA +50°C 1050mA
Storage temperature:	-40°C/+80°C
Overcharge protection:	Main surge immunity up to 10kV
Disconnecter:	Optional
Standard functions:	Current fixed CLO
Standard equipment:	Power cable type FG70M106 / 1kV 2x1.5, plug type IEC309 2P + T 230V 16A- IP67

Materials

Lighting fixture:	Die cast aluminium EN1706
Optical system:	Optics in PMMA Aluminium reflector, 99,7% oxidised and polished purity
Screen:	Screen-printed ultraclear tempered glass Th. 4mm
Gaskets:	Removable silicon
Cable gland:	Polyamide PA66 PG16 Ø 14mm MAX IP 66
Screws and bolts:	AISI 304 stainless steel
Bracket:	AISI 304 stainless steel
Fixture color:	GMR light
Silkscreen color:	RAL 9005

LED FEATURES

LED data 4.000 K - 700mA:	340 lm/LED 180 lm/W 25°C [Tj] ≤ 3 step MacAdam
Color temperature:	4.000 K 5.700 K CRI ≥ 70

Tarus Tunnel 200

Technical data

PERMANENT LIGHTING

TT2 P

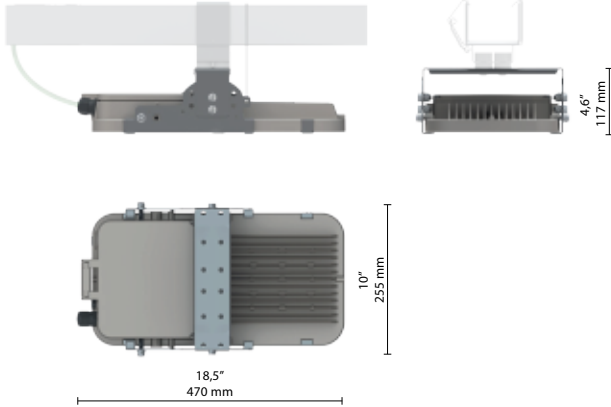

REINFORCEMENT LIGHTING

TT2 C

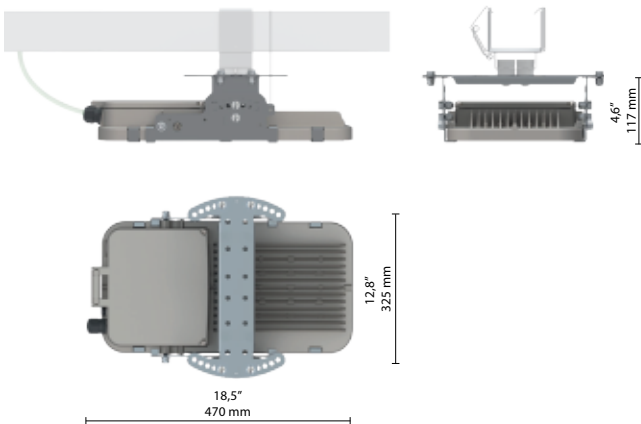

OPTIONAL

Mechanical equipment: Protection grille

Additional surge protector device: SPD with warning LED CLASS 1 | CLASS 2 12kV/kA

Electrical equipment: Disconnector and cable clamp | cross section 1.5mm² ÷ 4mm²

Optional functions: 1-10 V | DALI-DALI2 | DALI SENSOR

FOCUS: FIXING TUNNEL (*)

Rotation axes for cable channel installation

The tunnel version of Tarus was implemented to ensure safety and reliability in the permanent and reinforcement lighting of tunnels and galleries. The fastening systems developed provide for the possibility of adjusting the inclination of the body to compensate for any anomalies in the support.

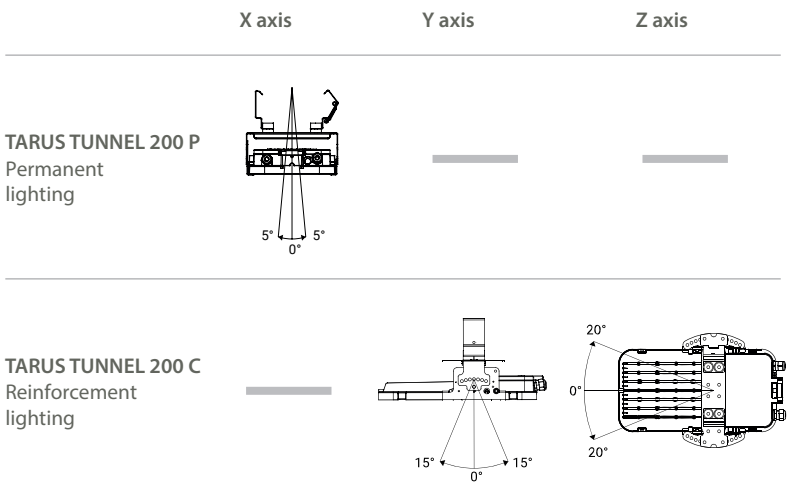

CLAMP FOR CABLE CHANNEL

A = 75 / 100 mm
2,95" / 3,9"
B = 100 ~ 300 mm
3,9" ~ 11,8"

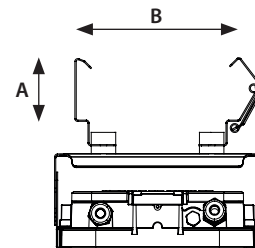

(*) Bracket dimensions and drilling are to be checked at the time of order.

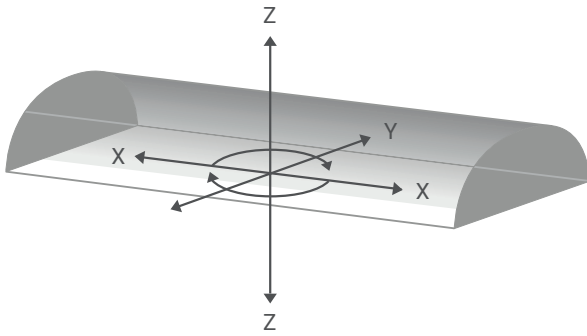

X AXIS - TT2 P

Central setup

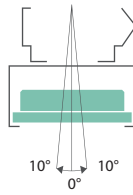

Arched tunnel



Squared tunnel

Side setup

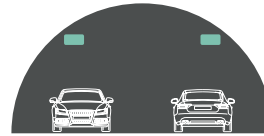
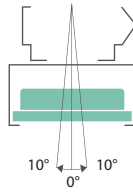

Arched tunnel



Squared tunnel

Bilateral setup

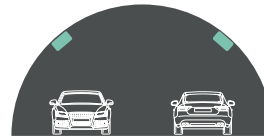
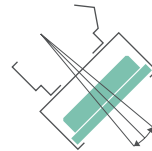

Arched tunnel



Squared tunnel

Y AXIS - TT2 C

Central setup, lateral and wall set up

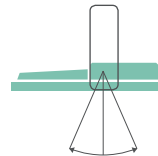

Z AXIS - TT2 C

Central setup

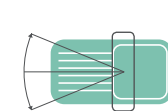

Bilateral setup

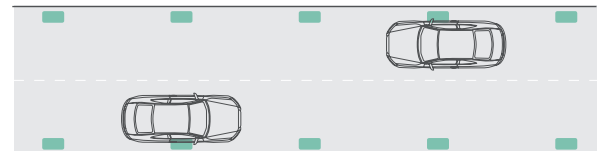
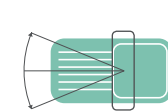

Bilateral wall setup

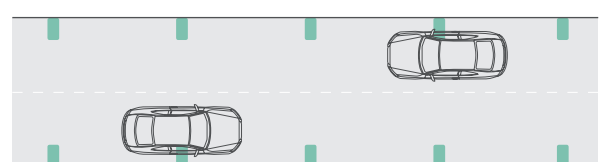

ASYMMETRICAL DISTRIBUTION\\ TYPE 1

1A

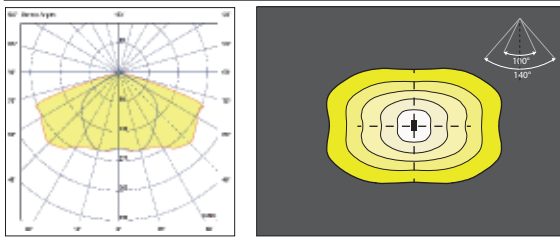

ASYMMETRICAL DISTRIBUTION\\ TYPE 2

2A

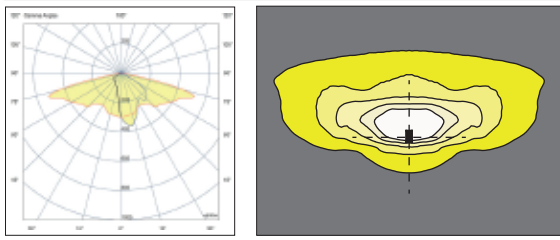

ASYMMETRICAL DISTRIBUTION\\ TYPE 3

3A

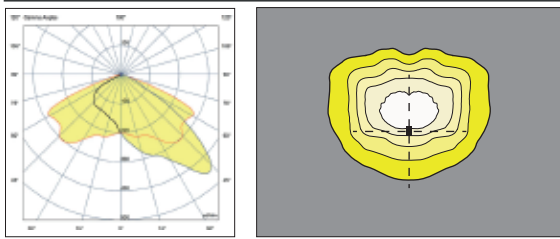

3B

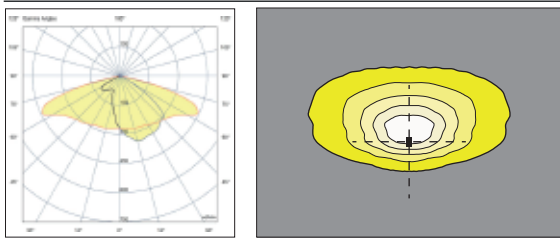

3C

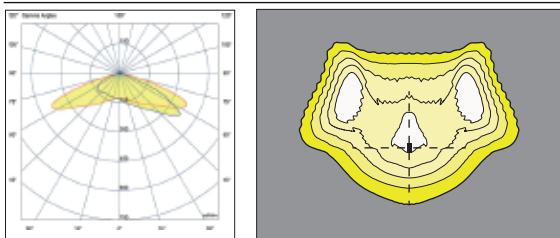

3D

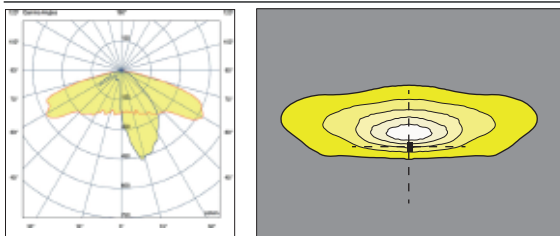

3E

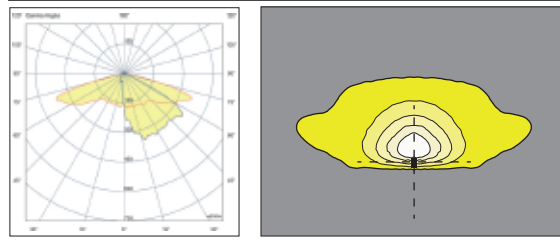

3F

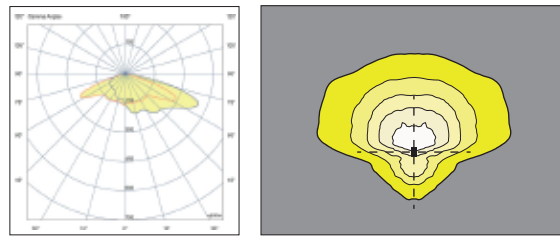

PEDESTRIAN PATHS\\ TYPE 4

4A

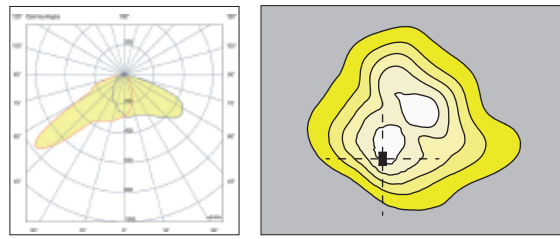

4B

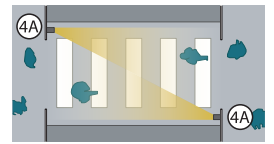
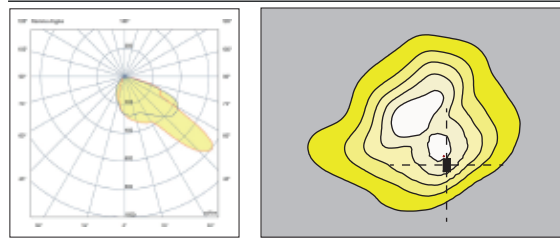

TYPE 4A

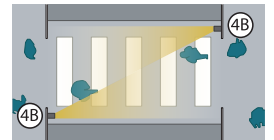

TYPE 4B

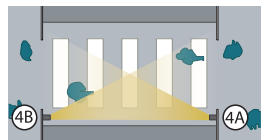

TYPE 4A + TYPE 4B

SYMMETRICAL DISTRIBUTION\\ TYPE 5

5A

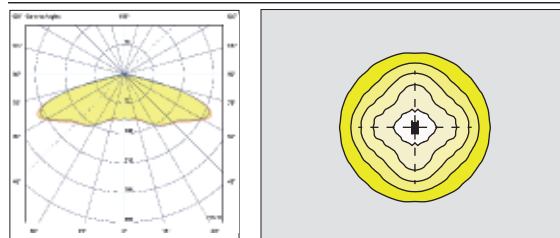

ROTO-SYMMETRICAL DISTRIBUTION\\ TYPE 9

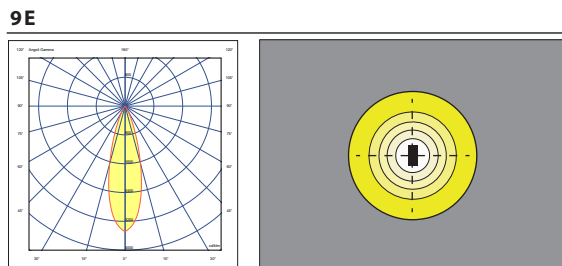
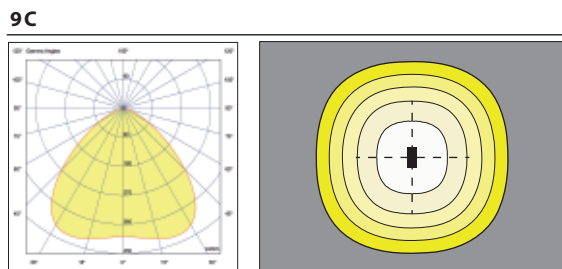
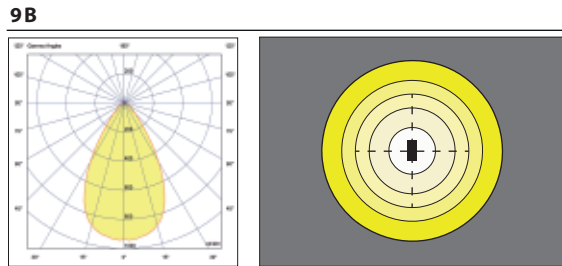
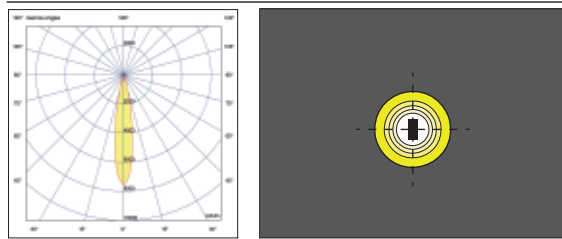



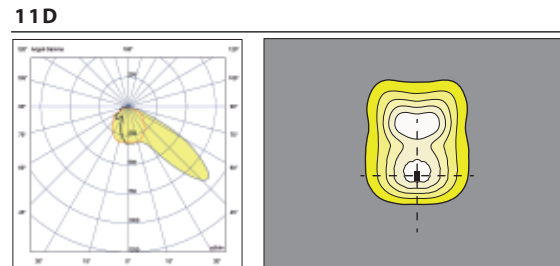
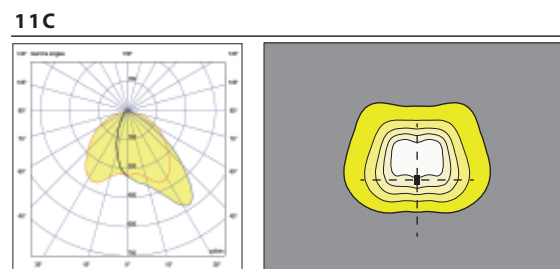
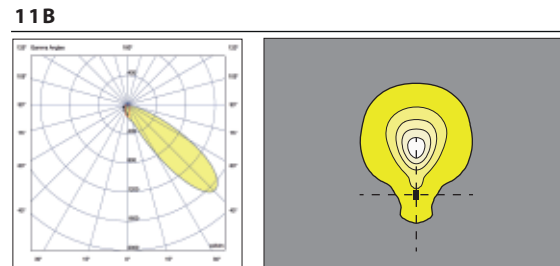
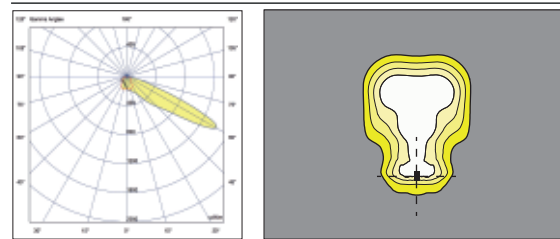

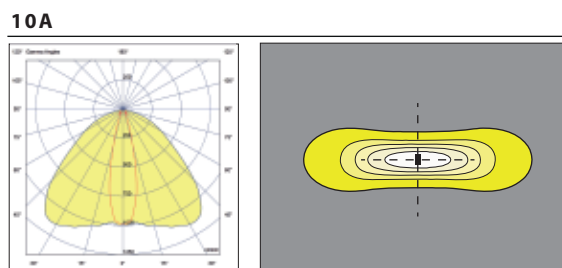

FLOODLIGHT DISTRIBUTION\\ TYPE 11



SYMMETRICAL DISTRIBUTION\\ TYPE 10



The LED modules nominal data refers only to the LED light sources in a standard version, with 4000 K color temperature, color rendering index CRI 70 min. and a junction temperature t_j of 25°C. The LED nominal data are extrapolated from the manufacturer documentations.

LED code		(*) I [mA]	Luminous flux [lm]	Power [W]	Efficiency [lm/W]
GL02		525	2168	12	181
		700	2951	17	174
		1050	4191	26	161
GL04		525	4337	24	181
		700	5729	33	174
		1050	8221	51	161
GL06		525	6505	36	181
		700	8506	49	174
		1050	12251	76	161
GL08		525	8674	48	181
		700	11284	65	174
		1050	16281	101	161
GL10		525	10842	60	181
		700	14235	82	174
		1050	20311	126	161
GL12		525	13010	72	181
		700	17013	98	174
		1000	23280	143	163

The lighting fixture measured data refers to GMR ENLIGHTS products in a standard version, with 4000 K color temperature, optica type 3B and an ambient temperature t_a of 25 °C.

GMR ENLIGHTS offers the possibility of driving the device with custom currents (*).

Feature availability is subject to configurations. To obtain luminous fluxes and efficiencies of the lighting fixture in case of optic type and/or color temperature and/or color rendering index different from the standard use the conversion factors shown in the tables.

Order code: TT2-P_GLxx
Order code: TT2-C_GLxx

		(*) I [mA]	Flusso luminoso [lm]	Potenza [W]	Efficienza [lm/W]
GL02		525	1859	14,5	128
		700	2421	19,0	127
		1050 (max)	3435	28,0	123
GL04		525	3719	27,0	138
		700	4810	36,0	134
		1050 (max)	6824	54,5	125
GL06		525	5541	39,5	140
		700	7166	53,0	135
		1050 (max)	10027	80,5	125
GL08		525	7338	52,0	141
		700	9425	70,0	135
		1050 (max)	13276	105,5	126
GL10		525	9110	65,0	140
		700	11700	86,0	136
		1050 (max)	16363	129,5	126
GL12		525	10858	76,0	143
		700	13943	102,0	137
		1000 (max)	18696	146,5	128

OPTIC CONVERSION FACTOR LUMINOUS FLUX

Optic type	Flux multiplier
3A 3C 3D 3E 3F	0,99
09A 09E	1,01
09B 09C	1,00
10A	1,00
11A 11B	0,99
11C	1,00

Tk CONVERSION FACTOR LUMINOUS FLUX

Tk [K]	Flux multiplier
3.000	0,94
5.700	1,01

CRI CONVERSION FACTOR LUMINOUS FLUX

CRI (color render index)	Flux multiplier
70	1,00
80	0,93

(*) See pag: Available optical system, to check the optic type availability.
(**) See pag: Technical data, to check the colour temperature availability.

Functions

Standard functionality

Fixed current

During production, the light fixture is pre-set with a fixed current amongst the standard settings that appear in the tables on page 3. Upon customer's request, it is also possible to set a specific current (custom setting).

Virtual Midnight | Automatic dimming

The driver is programmed to automatically dim the light output according to the time. As required by regulations, the maximum output is set during initial hours and towards the end of the light fixture's operating time interval. During these hours there is statistically more traffic. The light output is then dimmed during the central hours of the operating time interval. This management is achievable through a self-learning process of the device, that establishes the centre point of the time interval. This moment is called "virtual midnight" and it is the point that the dimming profile refers to in order to know when to reduce the light output. We can manage up to 8hrs of programming that evolve around the virtual midnight and up to 5 steps of dimming. This way the light output will adjust automatically, adapting throughout the year to the duration of the nighttime, by referring to the pre-set parameters based on the centre point of the operating time interval.

CLO Constant Lumen Output

LEDs over time are inevitably subject to performance depreciation. This light reduction may be compensated by gradually increasing the LED's current during its lifespan, this corresponds to a gradual increase of lumen output proportional to the amount that is naturally depreciated.

On request functionality

1-10V Analog control system

On request, the fixture can be equipped with 1-10V dimming interface. This protocol provides the possibility of dimming a single device or a public lighting line through a 1-10V control bus.

DALI - DALI2 Control and monitoring system

On request, the fixture can be fitted with a DALI2 communication interface. This protocol allows it to be monitored and controlled remotely through use of Dali control buses.

DALI SENSOR (D4i)

On request, the fixture can be equipped with a D4i certified power supply. This is the ideal solution for wireless sensors and/or controls. This system was developed to integrate various systems to address smart city requirements. Included is DALI2 protocol + auxiliary power (AUX) to supply power to devices and sensors. This system is usually required when using a Zhaga Lumawise socket.

LINESWITCH

This functionality by using an extra wire within the streetlight's power line, allows to dimmer to a pre-set level. For example, a centralised timer can change this value from 100% to 50%, and vice versa.

AMPDIM

This feature allows dimming using the power line controlled by an upstream flow regulator. For this feature, the flow controller must use amplitude modulation (AM).

On request connectors and external sockets

NEMA | Nema Socket (7 PIN)

The Nema Socket is a 7 PIN connector/socket with IP66 rating, that is fitted on the fixture to make it interfaceable with various ANSI C136 compliant devices and remote-control gear. These devices can be installed during or after installation of the light fixtures. The NEMA socket can provide power interruption and is interfaceable with DALI buses and/or 1-10V dimming. It is compatible with point-to-point node connection, and twilight sensors ect.

ZHAGA Lumawise Zhaga Socket (4 PIN)

The Lumawise Zhaga socket is a small and compact 4 Pin connector/socket, that is fits ideally with the design of GMR ENLIGHTS fixtures. With ZHAGA Lumawise sockets it is possible install the devices, sensors, ZHAGA remote controls during or after installation of the light fixtures. This socket is usually required in conjunction with the DALI Sensor feature, which involves a DALI2/D4i communication protocol in addition to 12/24V auxiliary port to supply power to the sensors. It is compatible with point-to-point wireless control solutions and SMART CITY applications to control and monitor the public lighting infrastructure.

Third-party remote control

GMR ENLIGHTS fixtures are compatible with most third-party remote controls, powerline communication systems, wired systems (buses) and wireless systems.

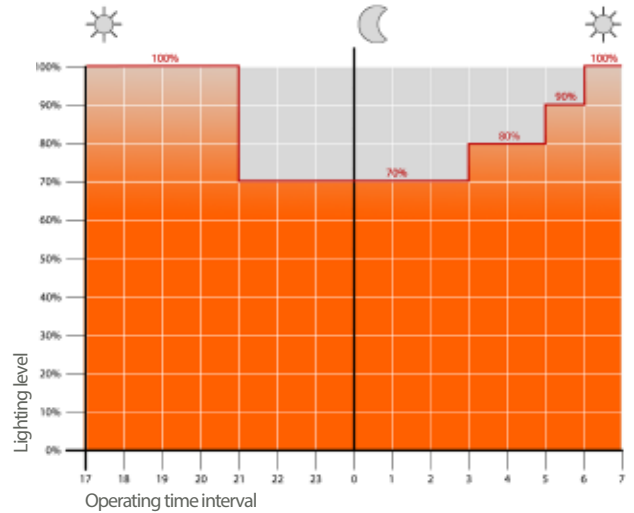

Example of 4-step adjustment with virtual midnight

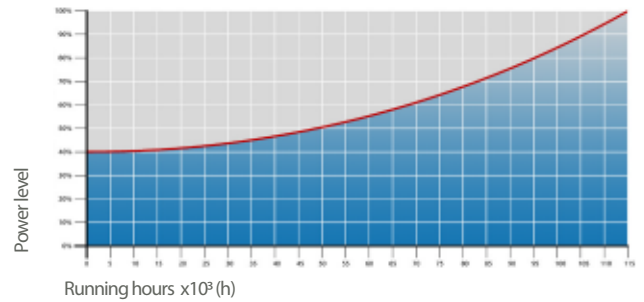

CLO Light Flow Compensation

7 Pin Nema Socket 7 (A) and IP66 shorting cap (B)

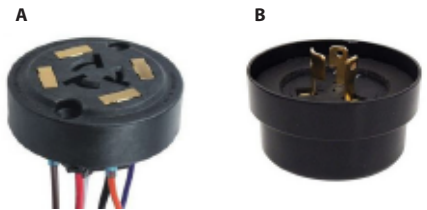

4 Pin Lumawise Zhaga Socket (C) and IP66 cap (D)



Installation example of Lumawise Zhaga



Protection cycles

GMR ENLIGHTS works with cast iron, steel and aluminum. The materials are selected and processed to maximize performance and quality.

GALVANIZED STEEL

Protection of galvanized steel surfaces for poles

The protection of galvanized steel elements is achieved by following steps:

- Micro sandblasting;
- First epoxy layer application followed by: Wilting > Drying > Cooling;
- Acrylic glaze layer application followed by: Wilting > Drying > Cooling;
- Packing at least after 24-hour-drying at room temperature.

Protection of galvanized steel surfaces for brackets and pastorals

The protection of the galvanized steel elements is achieved thanks to:

- Micro sandblasting;
- Phosphoric pickling bath at a ph level ranging from 1.5 to 3;
- Rinsing with demineralised water;
- First powder layer application;
- Kiln firing;
- Application of a final powder layer;
- Kiln roasting of the final powder layer at 180°C (356°F);
- Cooling.

CAST IRON

Protection of cast iron surfaces for bases

The protection of cast iron elements is achieved by the following treatments:

- Surface micro shotblasting;
- Mono-component dip galvanizing followed by: Wilting > Drying > Cooling;
- Epoxy micaceous primer application followed by: Wilting > Drying > Cooling;
- Acrylic enamel application followed by: Wilting > Drying > Cooling;
- Packing at least after 24-hour-drying at room temperature.

DIE-CAST ALUMINIUM

Protection of die-cast aluminium surfaces for lighting fixtures, tops, collars, brackets and pastorals

Lighting fixtures, brackets, pastoral, and die-cast accessories undergo a cycle of powder painting which creates a barrier against the corrosion of metal parts. Moreover this barrier makes the finished product comply with design specifications in terms of surface roughness, color and reflectance.

The cycle consists of the following steps:

- Micro sandblasting;
- Hot pickling bath in a zinc-based phosphodegreasing solution;
- Specific process for the preparation of surfaces before painting;
- Washing with water;
- Rinsing with demineralised water and subsequent drying;
- First powder layer application followed by kiln baking at 180°C (356°F);
- Final powder layer application using a High Durability product and final kiln roasting at 180°C (356°F).



Salt spray test

The top quality of such treatments is confirmed by salt spray tests performed in accordance with standard ISO 9227:2017 Neutral Salt Spray test (NSS).

The test was carried out for 8.000 hours at 35°C (95°F) and demonstrated through the report test released.



GMR ENLIGHTS s.r.l.

Legal headquarters:
Strada Provinciale Specchia - Alessano, 68 • 73040 (LE)

Administrative and operational headquarters:
Via Grande n°226 • 47032 Bertinoro (FC)

T +39 0543 462611
F +39 0543 449111

sales@gmrenlights.com
www.gmrenlights.com