



## **NOTTINGHAM**K

*The pictures shown are for illustrative purposes only. For shape, material and color specifications refer to internal descriptions.*

### ACCESSIBILITY

**Timeless**  
Tool-free openable fixture. Replaceable internal components without the need of tools.

### OPTICAL TECHNOLOGY

**Glass free**  
Refracting optical system consist of single-chip LED, shockproof lenses with 30 years of warranty against UV and yellowing by aging (GLASS-FREE).

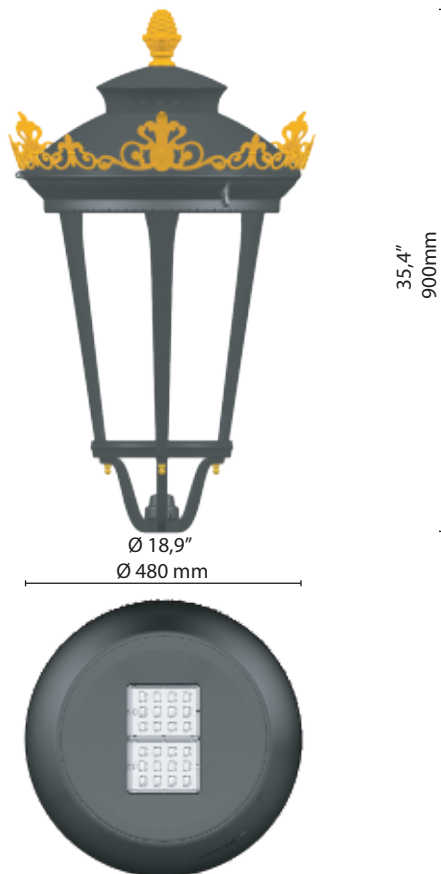

Scale: 1:15

**Max. weight** **CXS**  
14,6 Kg Lateral: 0,14 m<sup>2</sup> | Plan: 0,18 m<sup>2</sup>  
fixing device excluded

### FIXING TYPE

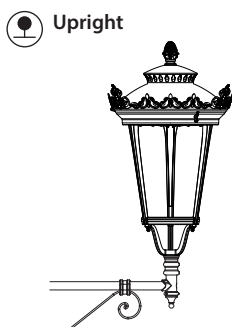
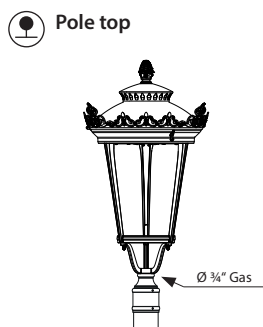

### OPTIONAL

**Glass**  
Ultraclear tempered glass  
Th. 0,15in (4mm)

1,7 lb  
0,8 Kg

**Diffusers**  
Polycarbonate with U.V. protection

**Quadrata**  
Ø14,3"-Ø365 mm  
2,8 lb  
1,3 Kg

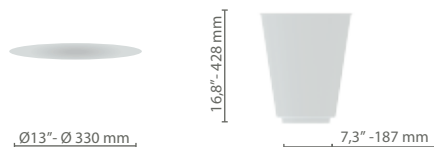

### STANDARD

EN 60598-1, EN 60598-2-3, EN 62471, EN 55015, EN 61547, EN 61000-3-2, EN 61000-3-3

### CONFORMITY | PROTECTION

#### Conformity



#### Salt spray test

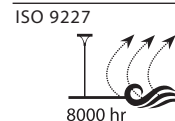

#### Insulation classes



#### Protection classes



#### Photobiological safety

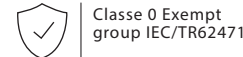

### PLUS



### LIGHTING FIXTURE FEATURES

#### General features

Power source:	220-240V   50/60Hz   tolerance +/-10%
	120-277V   50/60Hz   tolerance +/-10%
Current supply:	525 mA   700 mA   1000 mA (P <sub>max</sub> = 76W)
Power Factor   THD:	≥0.95   <10 % (At full load)
Expected life (Ta=25°):	> 100.000 h   L90B10   @ LED 700mA
Operational temperature (Ta):	T <sub>min</sub> = -40°C   T <sub>max</sub> = +55°C   700 mA +40°C   1000 mA
Storage temperature:	-40°C/+80°C
Overcharge protection:	Main surge immunity up to 10kV
Disconnecter:	Disconnecter and cable clamp   cross section 1.5mm <sup>2</sup> ÷ 4mm <sup>2</sup>
Standard functions:	Current fixed   Virtual midnight   CLO (page: Functionality)

#### Materials

Lighting fixture:	Die cast aluminium   EN1706
Optical system:	Optics in PMMA
Gaskets:	Removable silicon
Cable gland:	Polyamide PA66   PG16   Ø 14mm MAX   IP 68
Screws and bolts:	AISI 304 stainless steel
Fixture color:	GMR dark

### LED FEATURES

LED data 4.000 K - 700mA:	180 lm/W   25°C [Tj]   ≤ 3 step MacAdam
Color temperature:	2.200 K   3.000 K   4.000 K   5.700 K   CRI ≥ 70

#### Additional surge protector device:

SPD with warning LED CLASS 1 | CLASS 2 12kV/kA

#### Optional functions:

0,5 m power cable with 2-3 or 4-5 core connector

#### Funzionalità su richiesta:

(page: Functionality)  
1-10 V | DALI-DALI2 | SENSOR READY

#### Connectors and sockets:

(page: Functionality)  
NM (Nema Socket) | LM (Lumawise Zhaga Socket)

### ASYMMETRICAL DISTRIBUTION\\ TYPE 2 2A

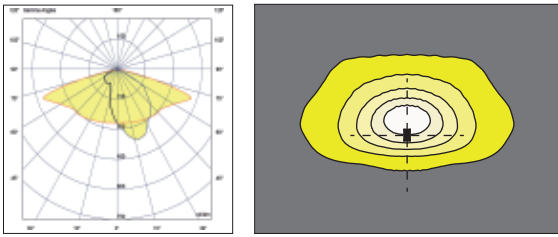

TYPE 2A

### ASYMMETRICAL DISTRIBUTION\\ TYPE 3 3A

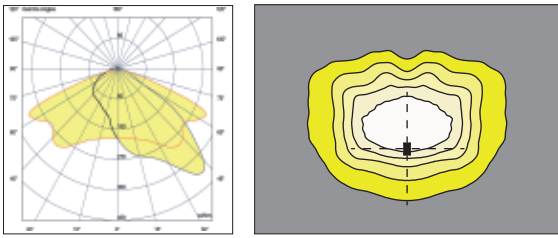

TYPE 2A

### 3B

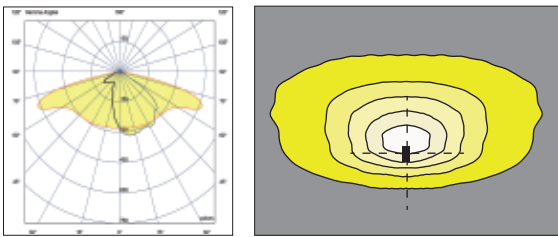



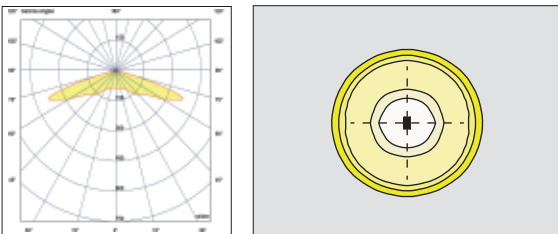

TYPE 3A | TYPE 3B

### ASYMMETRICAL DISTRIBUTION\\ TYPE 5 5A



TYPE 5A

The LED modules nominal data refers only to the LED light sources in a standard version, with 4000 K color temperature, color rendering index CRI 70 min. and a junction temperature  $t_j$  of 25°C. The LED nominal data are extrapolated from the manufacturer documentations.

LED code		(*) I [mA]	Luminous flux [lm]	LED Power [W]	Efficiency [lm/W]
GF02		525	2172	12,0	181
		700	2784	16,0	174
		1000	3912	24,0	163
GF03		525	3258	18,0	181
		700	4176	24,0	174
		1000	5787	35,5	163
GF04		525	4344	24,0	181
		700	5655	32,5	174
		1000	7743	47,5	163
GF06		525	6516	36,0	181
		700	8439	48,5	174
		1000	11655	71,5	163

The lighting fixture measured data refers to GMR ENLIGHTS products in a standard version, with 4000 K color temperature, optica type 3B and an ambient temperature  $t_a$  of 25 °C.

**GMR ENLIGHTS offers the possibility of driving the device with custom currents (°).**

In case of optional glass some LED codes may be different from those indicated (GL02, GL04, GL06). In this case the values of luminous flux and efficiency are different from those shown in the table.

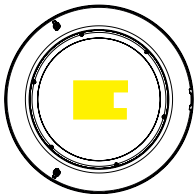
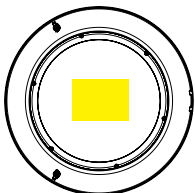
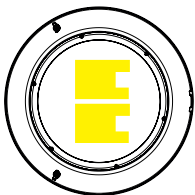
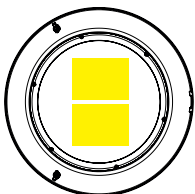
Order code: NOT S_GFVxx_K	(°) I [mA]	Luminous flux [lm]	LED Power [W]	Efficiency [lm/W]
<b>GF02</b> 	525	1871	14,5	129
	700	2396	19,5	123
	1000 (max)	3237	27,0	120
<b>GF03</b> 	525	2815	21,0	134
	700	3569	27,5	130
	1000 (max)	4823	39,0	124
<b>GF04</b> 	525	3655	27,5	133
	700	4727	36,0	131
	1000 (max)	6386	51,5	124
<b>GF06</b> 	525	5446	39,5	138
	700	7042	53,0	133
	1000 (max)	9513	76,0	125

### OPTIC CONVERSION FACTOR LUMINOUS FLUX

Optic type	Flux multiplier
1A (*)	1,00
2A (*)	0,99
3A	0,97
5A (*)	1,01

### Tk CONVERSION FACTOR LUMINOUS FLUX

Tk [K]	Flux multiplier
2.200 (**)	0,70
3.000	0,94
4.000	1,00
5.700	1,01

### CRI CONVERSION FACTOR LUMINOUS FLUX

CRI (color render index)	Flux multiplier
70	1,00
80	0,93

(\*) See pag: Available optical system, to check the optic type availability.

(\*\*) See pag: Technical data, to check the colour temperature availability.

# Functions

## Standard functionality

### Fixed current

During production, the light fixture is pre-set with a fixed current amongst the standard settings that appear in the tables on page 3. Upon customer's request, it is also possible to set a specific current (custom setting).

### Virtual Midnight | Automatic dimming

The driver is programmed to automatically dim the light output according to the time. As required by regulations, the maximum output is set during initial hours and towards the end of the light fixture's operating time interval. During these hours there is statistically more traffic. The light output is then dimmed during the central hours of the operating time interval. This management is achievable through a self-learning process of the device, that establishes the centre point of the time interval. This moment is called "virtual midnight" and it is the point that the dimming profile refers to in order to know when to reduce the light output. We can manage up to 8hrs of programming that evolve around the virtual midnight and up to 5 steps of dimming. This way the light output will adjust automatically, adapting throughout the year to the duration of the nighttime, by referring to the pre-set parameters based on the centre point of the operating time interval.

### CLO Constant Lumen Output

LEDs over time are inevitably subject to performance depreciation. This light reduction may be compensated by gradually increasing the LED's current during its lifespan, this corresponds to a gradual increase of lumen output proportional to the amount that is naturally depreciated.

## On request functionality

### 1-10V Analog control system

On request, the fixture can be equipped with 1-10V dimming interface. This protocol provides the possibility of dimming a single device or a public lighting line through a 1-10V control bus.

### DALI - DALI2 Control and monitoring system

On request, the fixture can be fitted with a DALI2 communication interface. This protocol allows it to be monitored and controlled remotely through use of Dali control buses.

### DALI SENSOR (D4i)

On request, the fixture can be equipped with a D4i certified power supply. This is the ideal solution for wireless sensors and/or controls. This system was developed to integrate various systems to address smart city requirements. Included is DALI2 protocol + auxiliary power (AUX) to supply power to devices and sensors. This system is usually required when using a Zhaga Lumawise socket.

### LINESWITCH

This functionality by using an extra wire within the streetlight's power line, allows to dimmer to a pre-set level. For example, a centralised timer can change this value from 100% to 50%, and vice versa.

### AMPDIM

This feature allows dimming using the power line controlled by an upstream flow regulator. For this feature, the flow controller must use amplitude modulation (AM).

## On request connectors and external sockets

### NEMA | Nema Socket (7 PIN)

The Nema Socket is a 7 PIN connector/socket with IP66 rating, that is fitted on the fixture to make it interfaceable with various ANSI C136 compliant devices and remote-control gear. These devices can be installed during or after installation of the light fixtures. The NEMA socket can provide power interruption and is interfaceable with DALI buses and/or 1-10V dimming. It is compatible with point-to-point node connection, and twilight sensors ect.

### ZHAGA Lumawise Zhaga Socket (4 PIN)

The Lumawise Zhaga socket is a small and compact 4 Pin connector/socket, that is fits ideally with the design of GMR ENLIGHTS fixtures. With ZHAGA Lumawise sockets it is possible install the devices, sensors, ZHAGA remote controls during or after installation of the light fixtures. This socket is usually required in conjunction with the DALI Sensor feature, which involves a DALI2/D4i communication protocol in addition to 12/24V auxiliary port to supply power to the sensors. It is compatible with point-to-point wireless control solutions and SMART CITY applications to control and monitor the public lighting infrastructure.

### Third-party remote control

GMR ENLIGHTS fixtures are compatible with most third-party remote controls, powerline communication systems, wired systems (buses) and wireless systems.

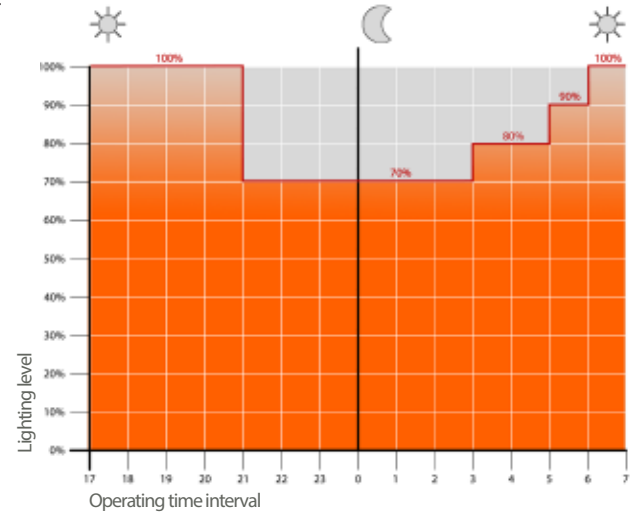

Example of 4-step adjustment with virtual midnight

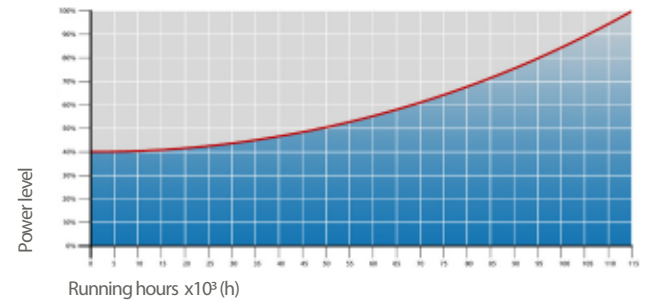

CLO Light Flow Compensation

### 7 Pin Nema Socket 7 (A) and IP66 shorting cap (B)

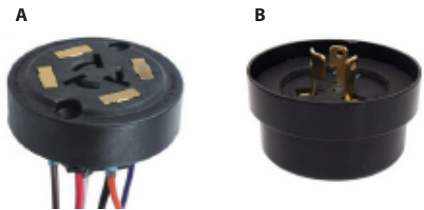

### 4 Pin Lumawise Zhaga Socket (C) and IP66 cap (D)



### Installation example of Lumawise Zhaga



## Protection cycles

GMR ENLIGHTS works with cast iron, steel and aluminum. The materials are selected and processed to maximize performance and quality.

### GALVANIZED STEEL

#### Protection of galvanized steel surfaces for poles

The protection of galvanized steel elements is achieved by following steps:

- Micro sandblasting;
- First epoxy layer application followed by: Wilting > Drying > Cooling;
- Acrylic glaze layer application followed by: Wilting > Drying > Cooling;
- Packing at least after 24-hour-drying at room temperature.

#### Protection of galvanized steel surfaces for brackets and pastorals

The protection of the galvanized steel elements is achieved thanks to:

- Micro sandblasting;
- Phosphoric pickling bath at a ph level ranging from 1.5 to 3;
- Rinsing with demineralised water;
- First powder layer application;
- Kiln firing;
- Application of a final powder layer;
- Kiln roasting of the final powder layer at 180°C (356°F);
- Cooling.

### CAST IRON

#### Protection of cast iron surfaces for bases

The protection of cast iron elements is achieved by the following treatments:

- Surface micro shotblasting;
- Mono-component dip galvanizing followed by: Wilting > Drying > Cooling;
- Epoxy micaceous primer application followed by: Wilting > Drying > Cooling;
- Acrylic enamel application followed by: Wilting > Drying > Cooling;
- Packing at least after 24-hour-drying at room temperature.

### DIE-CAST ALUMINIUM

#### Protection of die-cast aluminium surfaces for lighting fixtures, tops, collars, brackets and pastorals

Lighting fixtures, brackets, pastoral, and die-cast accessories undergo a cycle of powder painting which creates a barrier against the corrosion of metal parts. Moreover this barrier makes the finished product comply with design specifications in terms of surface roughness, color and reflectance.

The cycle consists of the following steps:

- Micro sandblasting;
- Hot pickling bath in a zinc-based phosphodegreasing solution;
- Specific process for the preparation of surfaces before painting;
- Washing with water;
- Rinsing with demineralised water and subsequent drying;
- First powder layer application followed by kiln baking at 180°C (356°F);
- Final powder layer application using a High Durability product and final kiln roasting at 180°C (356°F).



#### Salt spray test

The top quality of such treatments is confirmed by salt spray tests performed in accordance with standard ISO 9227:2017 Neutral Salt Spray test (NSS).

The test was carried out for 8.000 hours at 35°C (95°F) and demonstrated through the report test released.



**GMR ENLIGHTS s.r.l.**

Legal headquarters:  
Strada Provinciale Specchia - Alessano, 68 • 73040 (LE)

Administrative and operational headquarters:  
Via Grande n°226 • 47032 Bertinoro (FC)

T +39 0543 462611  
F +39 0543 449111

[sales@gmrenlights.com](mailto:sales@gmrenlights.com)  
[www.gmrenlights.com](http://www.gmrenlights.com)