

Steel Line Inclined large B pole arm

Product code: SIM L B

2020.10

01 | 02

-  Single
SIM L B_01
-  Double
SIM L B_02
-  Triple
SIM L B_03
-  Quad
SIM L B_04

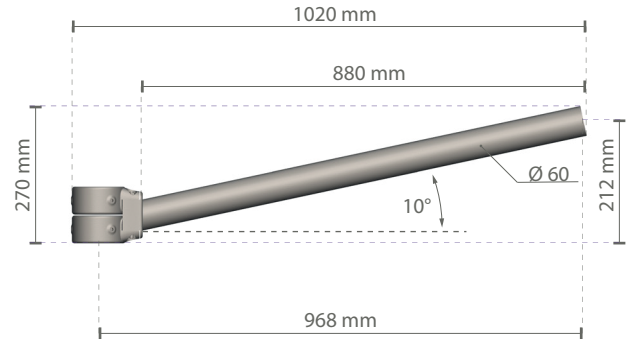
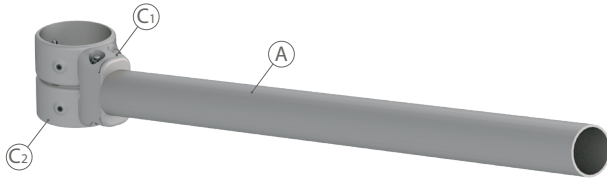

The drawings show the pole arm with Ø 89 pole collars, suitable for Steel Black poles fixing. The pole arm is equipped with Ø 79 pole collars for Steel Red or Steel Green poles fixing. (Ø 79 pole collars are shown in the pictures at the bottom.)

Scale: 1:15

Pole arm predisposed for the installation of lighting fixtures with lateral mounting on 7, 8, 9 e 10 m. poles.
The pole arm is available in single version for Steel Green poles, in single, double, triple or quad version for Steel Black and Steel Red poles.
The pole arm is equipped for the lighting fixtures fixing.

Geometry and mechanical features (*)

Height:	212 mm
Width:	880 mm (pole collar excluded)
Weight:	4,2 Kg (pole collar excluded)
Extension:	968 mm (Ø89 pole collar)

(*): Referred to single version

Materials | Color

Bracket (A):	S235 steel EN 10083-1
Pole collar joint (C1):	C30 steel EN 10083-1
Pole collar (C2):	C40 steel EN 10083-1
Decorative element (D):	Die-cast aluminium EN 1706
Screws and bolts:	AISI 304 stainless steel
Color:	Light grey

Pole collars (C2) Scale: 1:10

○ SIM L B_01

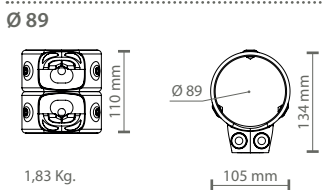

● SIM L B_02

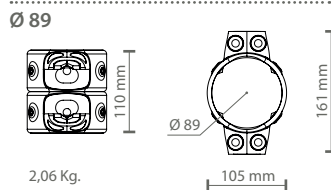

● SIM L B_03

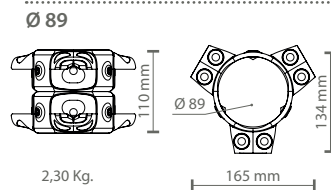

● SIM L B_04

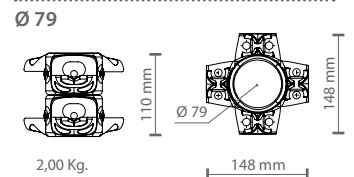
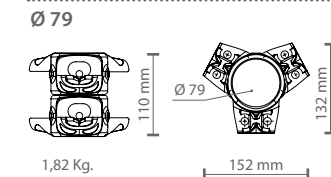
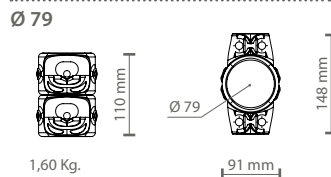
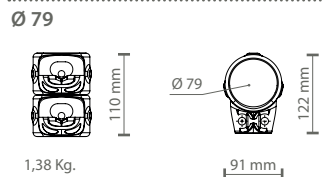
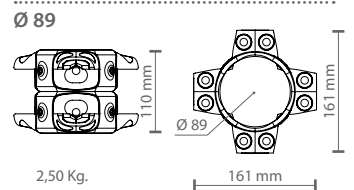

Protection cycles

GALVANIZED STEEL

Protection of galvanized steel surfaces for poles

The protection of galvanized steel elements is achieved by following steps:

- Micro sandblasting
- First epoxy layer application followed by: Wilting > Drying > Cooling
- Acrylic glaze layer application followed by: Wilting > Drying > Cooling
- Packing at least after 24-hour-drying at room temperature.

Protection of galvanized steel surfaces for brackets and pastorals

The protection of the galvanized steel elements is achieved thanks to:

- Micro sandblasting
- Phosphoric pickling bath at a ph level ranging from 1.5 to 3
- Rinsing with demineralised water
- First powder layer application
- Kiln firing
- Application of a final powder layer
- Kiln roasting of the final powder layer at 180°
- Cooling.

CAST IRON

Protection of cast iron surfaces for bases

The protection of cast iron elements is achieved by the following treatments:

- Surface micro shotblasting
- Mono-component dip galvanizing followed by: Wilting > Drying > Cooling
- Epoxy micaceous primer application followed by: Wilting > Drying > Cooling
- Acrylic enamel application followed by: Wilting > Drying > Cooling.
- Packing at least after 24-hour-drying at room temperature.

DIE-CAST ALUMINIUM

Protection of die-cast aluminium surfaces for lighting fixtures, tops, collars, brackets and pastorals

Brackets, pastoral, and die-cast accessories undergo a cycle of powder painting which creates a barrier against the corrosion of metal parts. Moreover this barrier makes the finished product comply with design specifications in terms of surface roughness, color and reflectance. The cycle consists of the following steps:

- Micro sandblasting
- Hot pickling bath in a zinc-based phosphodegreasing solution
- Phospho-chromatation for surfeces clearing
- Washing with water
- Rinsing with demineralised water and subsequent drying
- First powder layer application followed by kiln baking at 180°
- Final powder layer application using a High Durability product and final kiln roasting at 180°C.



Salt spray test | FLORIDA TEST

The top quality of such treatments is confirmed by the succesfull results of specific salt spray test (all products exceed widely 2.500 hours) and the strictest international tests, among which FLORIDA TEST.

The salt spray test is made in accordance with standard UNI EN ISO 9227.



GMR ENLIGHTS s.r.l.

Legal headquarters:
Strada Provinciale Speccia - Alessano, 68 - 73040 (LE)

Administrative and operational headquarters:
Via Grande n°226 - 47032 Bertinoro (FC)

T +39 0543 462611
F +39 0543 449111

sales@gmrenlights.com
www.gmrenlights.com