

# 30 2.0 small pole-top system

Product code: 30B S 20

- Two side lighting fixtures

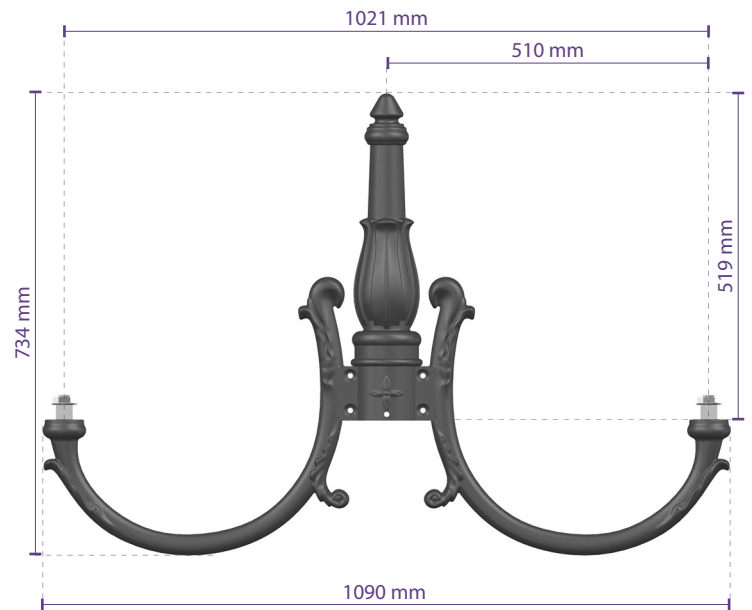

Scale: 1:12

Pole-top system predisposed for the installation of two standing lighting fixtures.  
Available on poles with SS column and ALM capital.  
The pole-top system is equipped for the pole fixing and for the lighting fixtures fixing.

## Conformity



## Geometry and mechanical features

Height:	734 mm
Width:	1090 mm
Extension:	510 mm
Weight:	14 Kg

## Materials | Color

Fixing plate (A):	C30 steel   EN 10083-1
Bracket (B):	Die-cast aluminium   EN 1706
Decoration (C):	Cast-iron   EN 1561
Decorative top (D):	Die-cast aluminium   EN 1706
Screws and bolts:	AISI 304 stainless steel
Color:	Dark grey "ferromicaceo" Ghisamestieri®

## Fixing plate (A)

Scale: 1:10

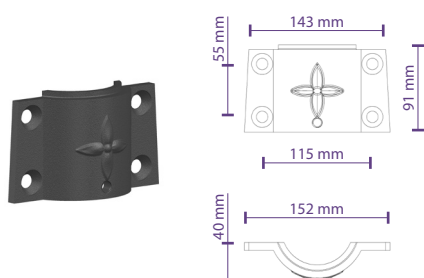

1,04 Kg.

## Bracket connection (B)

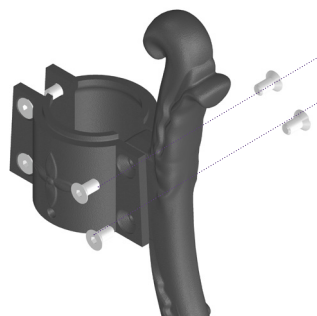

GMR ENLIGHTS works with cast iron, steel and aluminum. The materials are selected and processed to maximize performance and quality.

## GALVANIZED STEEL

### Protection of galvanized steel surfaces for poles

The protection of galvanized steel elements is achieved by following steps:

- Micro sandblasting;
- First epoxy layer application followed by: Wilting > Drying > Cooling;
- Acrylic glaze layer application followed by: Wilting > Drying > Cooling;
- Packing at least after 24-hour-drying at room temperature.

### Protection of galvanized steel surfaces for brackets and pastorals

The protection of the galvanized steel elements is achieved thanks to:

- Micro sandblasting;
- Phosphoric pickling bath at a ph level ranging from 1.5 to 3;
- Rinsing with demineralised water;
- First powder layer application;
- Kiln firing;
- Application of a final powder layer;
- Kiln roasting of the final powder layer at 180°;
- Cooling.

## CAST IRON

### Protection of cast iron surfaces for bases

The protection of cast iron elements is achieved by the following treatments:

- Surface micro shotblasting;
- Mono-component dip galvanizing followed by: Wilting > Drying > Cooling;
- Epoxy micaceous primer application followed by: Wilting > Drying > Cooling;
- Acrylic enamel application followed by: Wilting > Drying > Cooling;
- Packing at least after 24-hour-drying at room temperature.

## DIE-CAST ALUMINIUM

### Protection of die-cast aluminium surfaces for lighting fixtures, tops, collars, brackets and pastorals

Brackets, pastoral, and die-cast accessories undergo a cycle of powder painting which creates a barrier against the corrosion of metal parts. Moreover this barrier makes the finished product comply with design specifications in terms of surface roughness, color and reflectance. The cycle consists of the following steps:

- Micro sandblasting;
- Hot pickling bath in a zinc-based phosphodegreasing solution;
- Specific process for the preparation of surfaces before painting;
- Washing with water;
- Rinsing with demineralised water and subsequent drying;
- First powder layer application followed by kiln baking at 180°;
- Final powder layer application using a High Durability product and final kiln roasting at 180°C.



Salt spray test | FLORIDA TEST

The top quality of such treatments is confirmed by salt spray tests performed in accordance with standard ISO 9227:2017 Neutral Salt Spray test (NSS).

The test was carried out for 8.000 hours at 35 °C and demonstrated through the report test released.



**GMR ENLIGHTS s.r.l**

Legal headquarters:

Strada Provinciale Specchia - Alessano, 68 • 73040 (LE)

Administrative and operational headquarters:

Via Grande n°226 • 47032 Bertinoro (FC)

T +39 0543 462611

F +39 0543 449111

[info@gmrenlights.com](mailto:info@gmrenlights.com)  
[www.gmrenlights.com](http://www.gmrenlights.com)